

Artera Solus Play

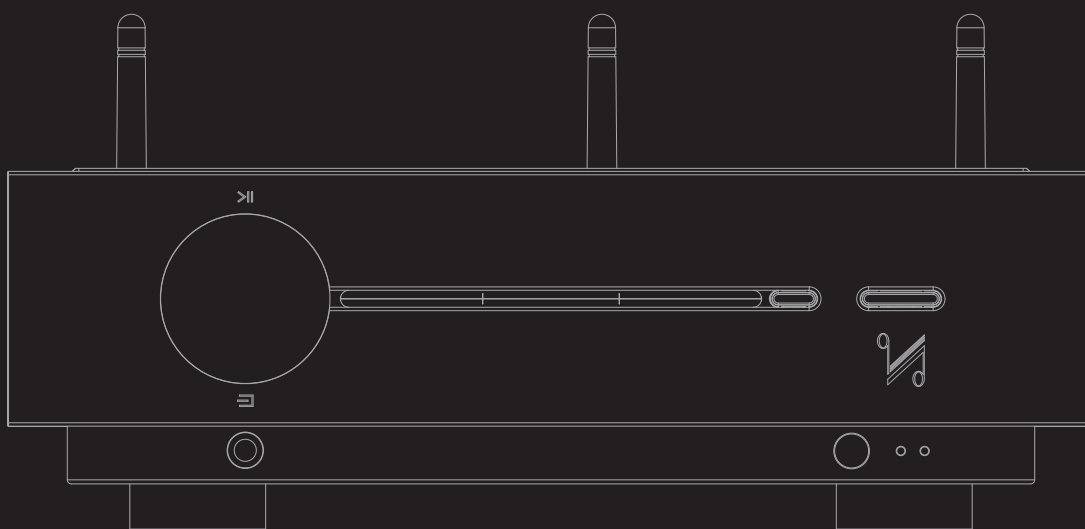

Wireless Streaming Integrated Amplifier / DAC / Preamplifier / CD Player

User Manual

QUAD

the closest approach to the original sound



IMPORTANT SAFETY INFORMATION



This lightning flash with arrowhead symbol within an equilateral triangle is intended to alert the user to the presence of non-insulated "dangerous voltage" within the product's enclosure that may be of sufficient magnitude to constitute a risk of electric shock.

Warning: To reduce the risk of electric shock, do not remove the cover (or back) as there are no user-serviceable parts inside. Refer servicing to qualified personnel.

This exclamation point within an equilateral triangle is intended to alert the user to the presence of important operating and maintenance instructions in the literature accompanying the appliance.

Read these instructions.

Keep these instructions.

Heed all warnings.

Follow all instructions.

Do not use this apparatus near water.

Clean only with dry cloth.

Do not block any ventilation openings. Install in accordance with the manufacturer's instructions.

Do not install near any heat sources such as radiators, heat registers, stoves, or other apparatus (including amplifiers) that produce heat.

Do not defeat the safety purpose of the polarized or grounding plug. A grounding plug has two blades and a third grounding prong. The wide blade or the third prong is provided for your safety. If the provided plug does not fit into your outlet, consult an electrician for replacement of the obsolete outlet.

Protect the power cord from being walked on or pinched particularly at the plugs, convenience receptacles, and at the point where they exit from the apparatus.



Use only with the cart, stand, tripod, bracket, or table specified by the manufacturer, or sold with the apparatus. When a cart or rack is used, use caution when moving the cart/apparatus combination to avoid injury from

tip-over.

Unplug this apparatus during lightning storms or when unused for long periods of time.

Refer all servicing to qualified service personnel. Servicing is required when the apparatus has been damaged in any way, such as power supply cord or plug is damaged, liquid has been spilled or objects have fallen into the apparatus, the apparatus has been exposed to rain or moisture, does not operate normally, or has been dropped.

WARNING: Only use attachments/accessories specified or provided by the manufacturer (such as the exclusive battery etc.).

WARNING: The mains plug/appliance coupler is used as disconnection device; the disconnection device shall remain readily operable.

CAUTION: These servicing instructions are for use by qualified service personnel only. To reduce the risk of electric shock, do not perform any servicing other than that contained in the operating instructions unless you are qualified to do so.

Do not install this equipment in a confined or built-in space such as a bookcase or similar unit, and keep well ventilated in open space. The ventilation should not be impeded by covering the ventilation openings with items such as newspaper, table-cloths, curtains etc.

WARNING: To reduce the risk of fire or electric shock, do not expose this apparatus to rain or moisture. The apparatus shall not be exposed to dripping or splashing and ensure that objects filled with liquids, such as vases, shall not be placed on the apparatus. No naked flame sources, such as lighted candles, should be placed on the apparatus.

WARNING: Do not ingest the battery, Chemical Burn Hazard. This product requires 2 x AAA type batteries (not included). If the battery is swallowed, it can cause severe internal burns in just 2 hours and can lead to death. Keep new and used batteries away from children. If the battery compartment does not close securely, stop using the product and keep it away from children. If you think batteries might have been swallowed or placed inside any part of the body, seek immediate medical attention.

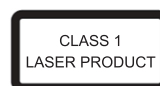

This label tells you that the unit contains a laser component. Opening the unit will expose the user to radiation from the laser beam.



This equipment is a Class II or double insulated electrical appliance. It has been designed in such a way that it does not require a safety connection to electrical earth.



This product will generate certain heat during use. Please pay attention to the hot surface.

WARNING: No naked flame sources, such as lighted candles, should be placed on the apparatus.

WARNING: Attention should be drawn to environmental aspects of battery disposal.

WARNING: Use of the apparatus in tropical climates.

QUAD

Artera Solus Play

CONTENTS

| | |
|---|---------------------------|
| IMPORTANT SAFETY INFORMATION | Inside Front Cover |
| INTRODUCTION | 4 |
| UNPACKING THE EQUIPMENT | 4 |
| USB DRIVERS (AND FIRMWARE UPDATES) | 4 |
| PLACEMENT | 4 |
| REMOTE HANDSET | 5 |
| CONTROLS AND CONNECTIONS | 7 |
| INSTALLATION | 8 |
| SYSTEM CONNECTION | 12 |
| OPERATION | 13 |
| BLUETOOTH | 19 |
| DTS PLAY-FI® WIRELESS STREAMING TECHNOLOGY | 20 |
| DOWNLOAD THE APP | 21 |
| WI-FI CONNECTION USING THE APP | 22 |
| WI-FI CONNECTION SETUP USING A WINDOWS PC OR MAC | 24 |
| APP OPERATION | 26 |
| MENU SETTING | 32 |
| SPECIFICATIONS | 35 |
| CARE AND CLEANING | 36 |
| WARRANTY | 36 |
| SERVICE | 36 |
| INTERNATIONAL SERVICE CENTRE | 36 |



The Bluetooth® word mark and logos are registered trademarks, owned by Bluetooth SIG, Inc. and any use of such marks by IAG Group Ltd is under license. Other trademarks and trade names are those of their respective owners.



aptX® software is copyright CSR plc. or its group companies. All rights reserved.

The aptX® mark and the aptX logo are trademarks of CSR plc. or one of its group companies and may be registered in one or more jurisdictions.

INTRODUCTION

Thank you for your investment in the QUAD Artera Solus Play. We are sure that the Artera Solus Play will continue to delight you for years to come, thanks to its future-proof provisions for music playback sources.

The QUAD Artera Solus Play is designed to be the perfect match for all of your music sources and provides the necessary amplification to realise the highest quality of your music, regardless of the source.

You can link the Artera Solus Play to both analogue and digital sources, thanks to its diversity of inputs. An innovative aptX codec provides CD quality audio over Bluetooth connection. You can also make use of wireless audio streaming and multi-room systems with the built-in DTS Play-Fi technology.

With DTS Play-Fi® Technology, music can be streamed over your wireless network in high resolution format and can be easily expanded to an ultimate multi-room system, if required. You can stream from any source on your wireless network, including smart-phones, tablets or PCs as well as a NAS Drive.

DTS Play-Fi extends the functionality of the Artera Solus Play as a Bluetooth aptX / CD player / DAC / Preamp.

Please read this manual carefully to discover all the ways you can connect your equipment to the QUAD Artera Solus Play and learn how to get the best performance from all of your music sources.

UNPACKING THE EQUIPMENT

The carton contains:

- The QUAD Artera Solus Play
- One IEC mains cable with a plug suitable for your area
- Three receiver antennas
- One glass top
- One remote controller
- One QUAD Artera Solus Play user manual

Please note: The remote control requires 2 x AAA type batteries. Due to international shipping and courier regulations with Lithium Ion batteries, the remote controller battery is not included in this package.

Consult the dealer from whom you purchased the equipment if any item is not present. Carefully unpack the unit and accessories. Take care not to damage the surface finish when undoing the protective polythene sleeve. Retain the packing materials for future use. Retain the user manual and information concerning the date and place of purchase of your equipment for future reference. If you transfer the unit to a third party please pass on this instruction manual along with the equipment.

USB DRIVERS (AND FIRMWARE UPDATES)

To download Windows Drivers, please see the separate manual. Any firmware updates will also be available from www.quad-hifi.co.uk

PLACEMENT

The unit must be mounted on a solid, level and stable surface. If you are likely to play your system at high volume levels, the Artera Solus Play should be mounted on its own shelf with sufficient ventilation above and to the sides and rear.

Before you connect the Artera Solus Play to the mains, ensure your AC mains voltage corresponds to the rating on the rear panel of the product. If in doubt, consult your dealer. If you move to an area which has a different AC mains voltage, seek advice from a QUAD appointed dealer or a competent service technician.

REMOTE HANDSET

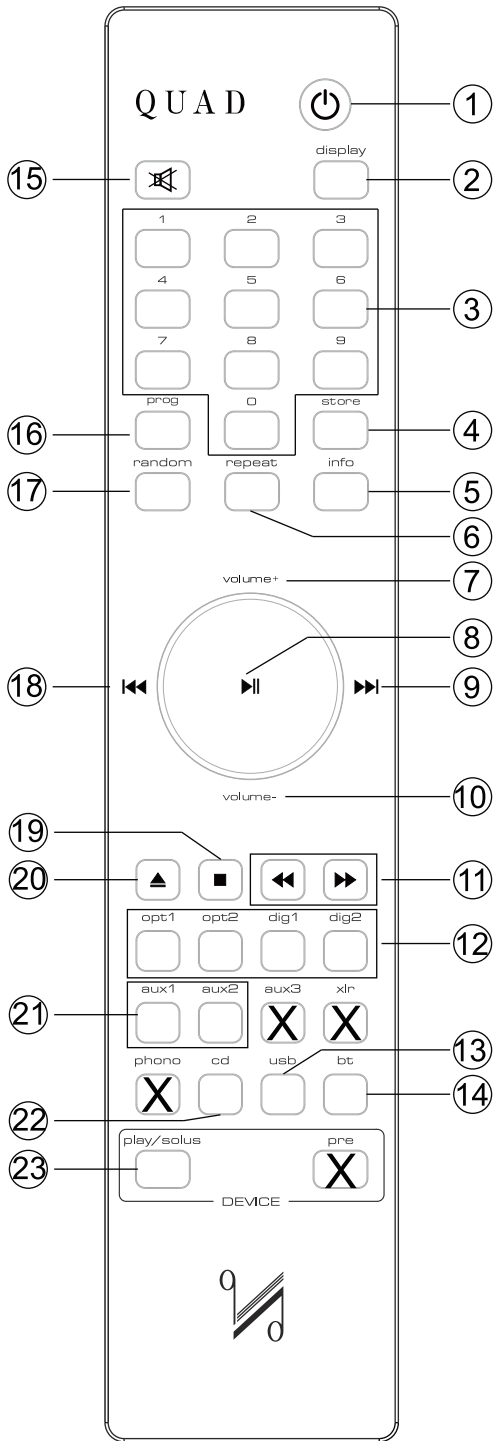

- | | |
|---------------|---|
| 1 Standby | Press to enable/disable standby |
| 2 Display | Press to alter the display ON/OFF |
| 3 Number keys | Select tracks |
| 4 Store | Press to store a track in Program mode |
| 5 Info | Press to display more information |
| 6 Repeat | Press to select a repeat mode |
| 7 Volume+ | Increase volume |
| 8 | Play/Pause, for CD/USB / BT / Play-Fi/ Spotify playback |
| | Press and hold to disconnect the Bluetooth device |
| | The menu setting enter key |
| 9 | Select next track |
| | Press to switch the Menu setting |
| 10 Volume- | Decrease volume |
| 11 | Press and hold to Fast reverse/Fast forward search |
| 12 Digital | Press to select Digital inputs |
| | Press and hold to select DPLL bandwidth |
| 13 USB | Press to select the USB input |
| 14 BT | Press to select Bluetooth |
| 15 Mute | Press to mute/unmute the sound |
| 16 Prog | Press to enter a program of tracks |
| | Press and hold to enter Menu setting |
| 17 Random | Press to select/deselect random play |
| 18 | Press once to replay the current track |
| | Press again to move to the previous track |
| | Press to switch the Menu setting |
| 19 | Press to stop CD Playback |
| 20 | Press to eject/load the disc |
| 21 Aux1/Aux2 | Press to select analogue inputs |
| 22 CD | Press to select CD playback |
| 23 Play/Solus | Press to select Artera Solus Play mode |

Remote Controller Preparation

- Unpack the handset
- Invert the handset
- Remove the battery cover
- Insert 2xAAA type new batteries (not supplied)
- Close the battery cover

Futura Hv BT

To prevent any burning, fire, or any possible harm to the environment or human health from the depleted batteries, please correctly dispose of the waste batteries in light of the recycling rules in your area. Don't dismantle, crush or puncture the batteries. Never short-circuit the batteries, throw the batteries into the water or fire or even try to repair them.

Handset Operation

Point the handset at the remote receiver and press the relevant key. The handset should be within 15 metres of the player and there must be a clear line of sight between the two units.

Selecting tracks with the number keypad:

If there are less than 10 tracks: pressing any number will begin playback from the track selected.

If there are 10 - 19 tracks: If you press any key other than "1" the player will jump to the track.

If "1" is pressed the player will pause briefly to allow you to enter another digit. If no key is pressed within the three seconds, track 1 will play.

If there are between 20 & 29 tracks: If you press any key other than "1" or "2" the player will jump directly to the track. If you press "1" or "2" the player will pause briefly to allow you to enter another digit before starting playback, and so on.



CONTROLS AND CONNECTORS

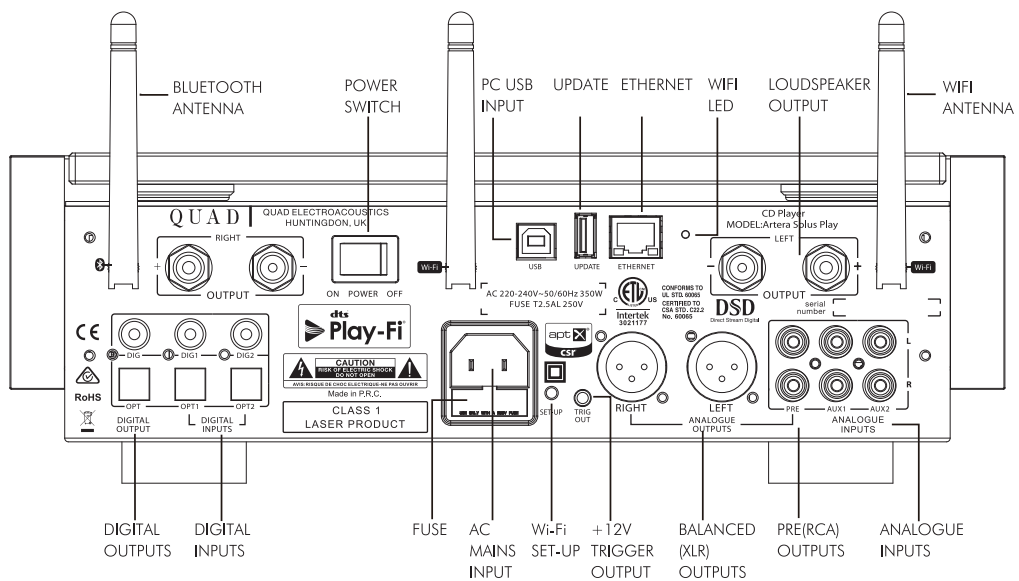
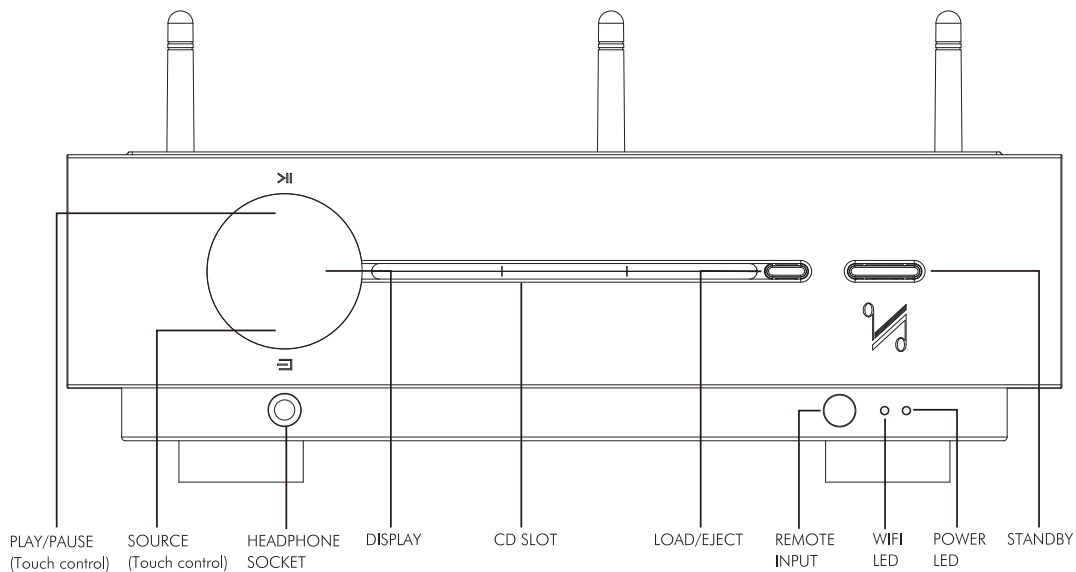

INSTALLATION

Open the carton box, take out the glass top and the Artera Solus Play separately. Place the Artera Solus Play onto a sturdy shelf or table. Put the glass top on the lid of Artera Solus Play after making all connections.

Before making any connections to your high fidelity equipment make sure that all units in the system are switched off and unplugged at the mains.

Mains Connections

Before connecting your QUAD equipment to the AC mains supply, check and make sure the voltage marked on the back matches the voltage of your supply.

Power On/Off switch

The Power On/Off switch is on the rear panel of QUAD Artera Solus Play. When the TRIG OUT(+12V) of Artera Solus Play is connected to TRIG IN of QUAD Artera Stereo using a 3.5mm mono cable then the triggers are ready for the connection. This switch should be left switched on as the Artera Solus Play will remotely switch QUAD Artera Stereo on when it is brought in and out of standby. The On/Off switch may be switched off when Artera Stereo or Artera Solus Play is not in use.

Analogue Signal Input Connections

The Unbalanced Input

AUX1 and AUX2 are two sets of RCA unbalanced analogue inputs.

Connect RCA phono interconnects between the unbalanced input on the Artera Solus Play rear panel with the matching output of the source unit. Interconnects should be of low-noise construction and fully screened to minimize hum and noise transmission.

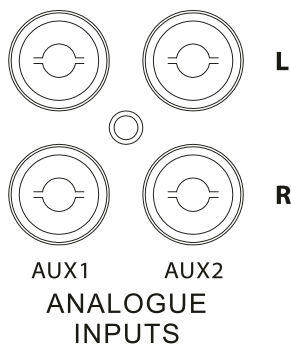

Analogue Signal Output Connections

The XLR Balanced Output

If you are connecting a QUAD Artera Solus Play to a QUAD Artera Stereo or other amplification with balanced inputs we strongly advocate the use of the balanced XLR connections.

A major advantage of balanced interconnects is the suppression of ground loop problems. Balanced line inputs use 3 conductors, one for the ground and two for the voltage difference between the signal and the ground at the source unit. The signal is thus 'cleaner' and free from earth-induced currents and other LF artefacts and provides an improved S/N ratio.

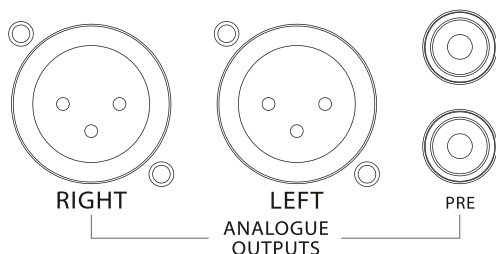

The Unbalanced Output

The QUAD Artera Solus Play has one set of unbalanced RCA analogue signal outputs (PRE) for connection to units which do not feature balanced inputs.

Headphone Output

A stereo 6.3mm(1/4") jack is provided on the front panel for connecting headphones. Connecting headphones mutes the audio signal to the speaker outputs. Artera Solus Play headphone output is graded up to 100, users can select a comfortable output level to suit their headphones.

Caution: When using headphones, playing music at very high volumes may permanently damage your hearing.



Digital Signal Input Connections

As the DACs in the Artera Solus Play will be superior to those of regular DVD players, DVB receivers, etc. we urge you to use the digital inputs of the Artera Solus Play for superior sound reproduction. The digital inputs are customizable to suit your source equipment.

Coaxial Inputs

DIG1 and DIG2 are coaxial SPDIF inputs. Connect an RCA digital interconnect between the digital coaxial output of the source unit to the required input on the Artera Solus Play.

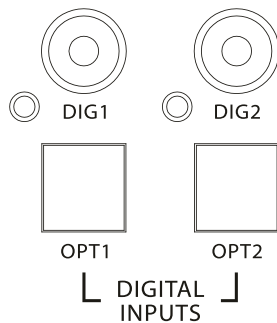

Optical Inputs

OPT1 and OPT2 are optical SPDIF inputs. Connect an optical (TOSlink) interconnect between the digital optical output of the source unit to the required input on the Artera Solus Play.

USB Input

The USB input enables you to connect a Mac or PC to the Artera Solus Play for playing audio files stored on a computer. Connect a USB cable between a USB port on the computer to the USB input on the Artera Solus Play.

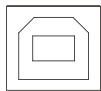

USB

Digital interconnects should be adequately specified and kept short to optimise performance.

Digital Signal Output Connections

Two digital outputs are provided. These outputs are for those who wish to connect the Artera Solus Play to the digital (SPDIF) inputs of external devices.

DIG & OPT Outputs

A coaxial and an optical output are available. These are the connections that will be normally used to connect the Artera Solus Play to external standard audio DACs.

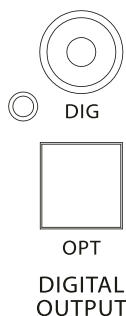

Software Update

Artera Solus Play supports USB disk upgrade:

Put the file "Artera.bin" on the USB disk, plug it into the UPDATE USB interface, press and hold the "STANDBY" button on the front panel while switching the power on (using the rear panel switch). Artera Solus Play will upgrade automatically.



UPDATE

Ethernet Port

Use a suitable cable to plug the Ethernet Port to the LAN port of a wireless router for wired connection. It is recommended to use a wired connection when playing high resolution audio, which makes the playback more stable and smooth.

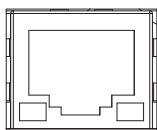

ETHERNET

Speaker Output

One pair of amplifier outputs is provided on the rear panel to connect loudspeakers. Loudspeaker cables should be prepared carefully. Make sure that all channels are connected in phase. The positive (red) output terminal of each channel should be connected to the positive (red) terminal of the speaker.

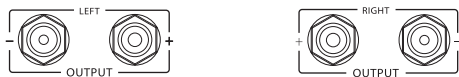

Wi-Fi / Bluetooth Antenna

DTS Play-Fi is compatible with any router which is authenticated to Wi-Fi standards. We recommend the use of 802.11n or better which enables 2.4GHz and 5GHz transmission frequencies. If you have the option, 5GHz connection will give the most stable performance.

Bluetooth uses the same antenna as Wi-Fi, and supports the 2.4GHz frequency band. In order to achieve the best effect and the best stability of Bluetooth playback, please position the antenna vertically and the broadcasting device within 10m.

Trigger Connections

If you have a Quad Artera system, we advise connecting the trigger. This will enable all Artera units to be brought in and out of standby along with trigger inputs and outputs.

To connect the triggers, you will need a cable with one end to match the trigger input of the slave unit and other terminating in a 3.5mm jack plug. For Artera series units, this will be a 3.5mm to 3.5mm interconnect.

The triggers on the Artera Solus Play are master (output) triggers. They are used exclusive to control other equipment.

Connect the TRIG OUT of Artera Solus Play to the "TRIG IN" of Artera Stereo or other Artera series unit, or any other slave unit having a 12V trigger in.

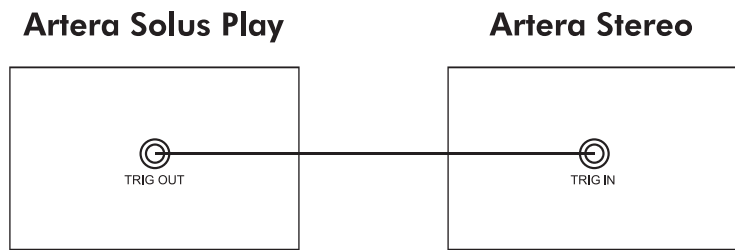

SYSTEM CONNECTION

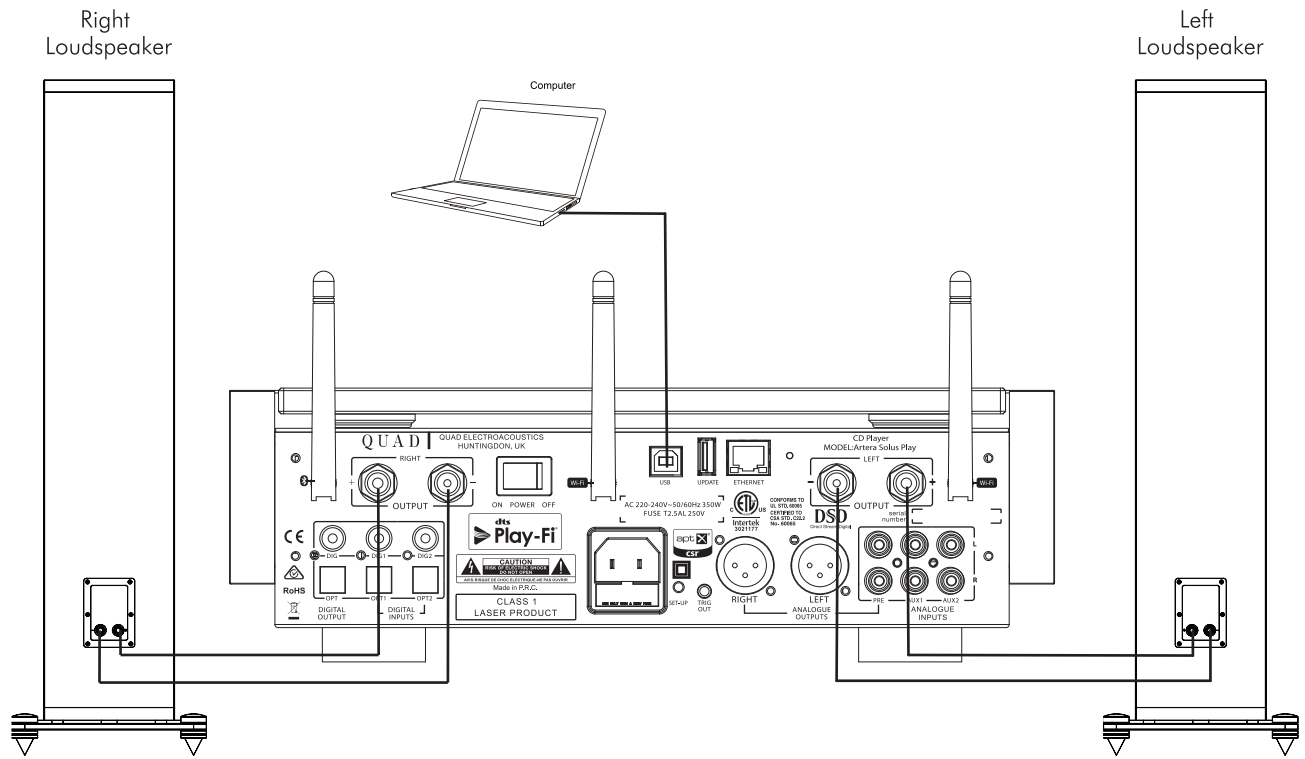

OPERATION

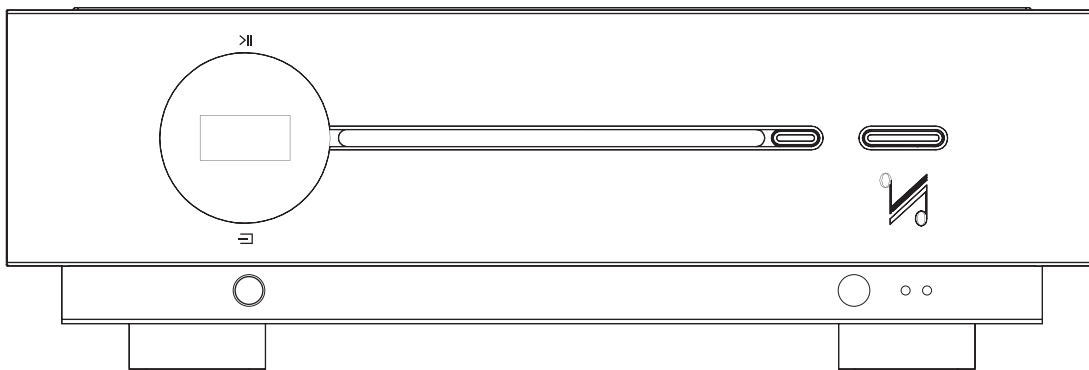

Switching On

The power supply input is via an IEC AC connector and an appropriate power lead is supplied. Connect the power leads to all system components and then to the wall sockets ensuring that the power switches on all units and wall sockets are switched off.

Check that all leads are correctly installed. Switch on the AC supply to the source units and the power amplifier/s. All connected unit/s will go to Standby and the Power LED/s on the front panel/s will indicate Red.

If the trigger system is connected: Press the Standby button on the Artera Solus Play or on the remote handset. The connected Artera Stereo will go from Standby to "Active". The Display of Artera Solus Play lights up.

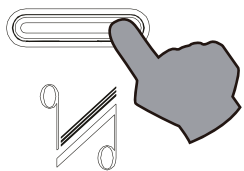

Auto Standby Mode

Auto Standby mode is not active by default. Auto Standby is provided to offer low-power settings that save energy and can be simply adjusted by using the Standby button. Press and hold the Standby button on the front panel while the unit is on for 3 seconds. "Auto Standby 20 Minutes" will appear briefly on screen and the Power LED will flash twice.

In status Auto Standby, Artera Solus Play will automatically go into standby mode when there is no signal input and operation for 20 minutes, or if the CD has not played for 20 minutes (or 1 hour depending on the user preference / setting)

To exit Auto Standby mode:

- Press and hold the Standby button on the front panel during the operating state for 3 seconds, "Auto Standby Never" will appear briefly on screen and the Power LED will flash once, Artera Solus Play will disable Auto Standby mode.
- Power Off and On again, Artera Solus Play will be reset.

Power Up Sequence

Switch on display: The welcome screen displays "QUAD" for 5 seconds, indicating that the Player has powered on successfully.

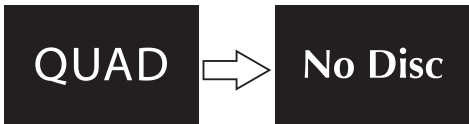

Selecting an Input

Besides CD, available playback connections include Bluetooth, USB, Play-Fi, two optical, two coaxial and two analogue inputs. Short touch the SOURCE button on the front panel repeatedly to cycle the inputs CD, BT, Play-Fi, AUX1, AUX2, OPT1, OPT2, DIG1, DIG2, USB. Or simply press the required button on the handset to select the desired input.

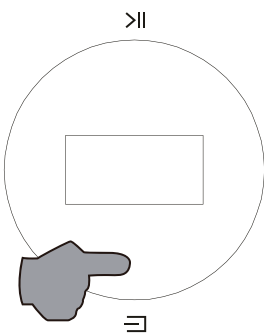

Loading a CD

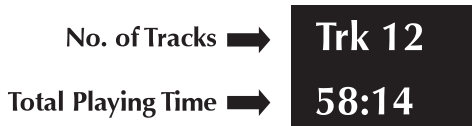

Insert a CD into the slot, the Solus will automatically start to load the disc and display the Table of Contents then stop

Ejecting a CD

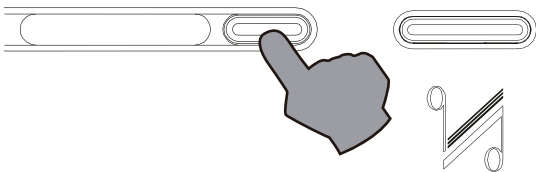

Press the Load/Eject key on the front panel or the handset, remove the disc and "No Disc" is displayed.

If the disc is not removed within ten minutes the Artera Solus Play will reload and read the disc.

Playing a CD

To play a CD from the start: Press the Play/Pause key on the handset or touch the Play/Pause button on the front panel.

To play a CD from a selected track:

- (1) Repeatedly press the **⏮ / ⏭** on the handset. When the desired track is reached, stop pressing and the player will play from the selected track.
- (2) Enter the required track number from the handset. The disc will play from the selected track.

Pausing a CD during play

Press the Play/Pause key on the handset or touch the Play/Pause button on the front panel, pause icon appears briefly on screen, the CD will pause.

Press the Play/Pause key on the handset or touch the Play/Pause button on the front panel again, play icon appears briefly on screen, the CD will resume play.

Note: The CD will stop if CD playback is paused for 3 minutes.

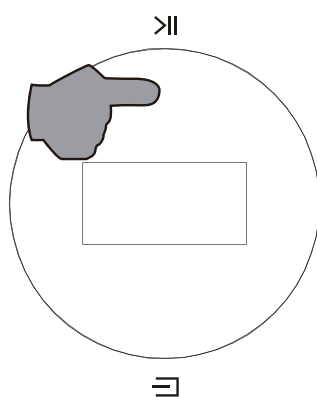

Selecting tracks during play

- (1) Repeatedly press the **⏮ / ⏭** on the handset or quick touch the Play/Pause button on the front panel twice to continually select NEXT TRACK. When the wanted track is reached stop pressing and the player will play from the selected track.
- (2) Enter the required track number from the handset. The disc will play from the selected track.
For handset operation refer to Page 5.

Forward and Reverse Search during play:

Press and hold the **⏮ / ⏭** on the handset. The forward and reverse search will start. Play reverts to normal when the key is released.

Random Play

- Press the Random key on the handset to play all the tracks on the disc in random sequence. The Random On icon appears briefly on screen.
- Press the info key on the handset, the Random icon will be displayed.



- Press the Random key again to return to the normal sequence. The Random Off icon appears briefly on screen.

Repeat Play

- Press the Repeat key once to repeat one track continuously. The Repeat 1 icon appears briefly on screen. You can also select a new track and this will be continuously repeated. Press the info key on the handset, the Repeat 1 icon will be displayed.

Repeat 1

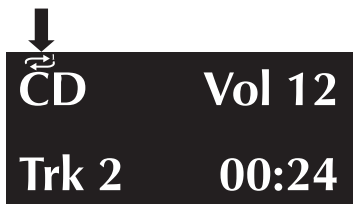

- Press the Repeat key twice to repeat all the tracks on the disc continuously. The Repeat All icon appears briefly on screen.
- Press the info key on the handset, the Repeat All icon will be displayed.

Repeat All

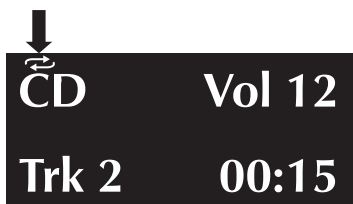

- Press the Repeat key again to cancel repeat mode, the Repeat Off icon appears briefly on screen.

Stopping a disc

- (1) Press the Stop key on the handset. If Random or Repeat play is selected, pressing Stop key does not cancel these options. They must be cancelled as described above.
- (2) Eject and load the disc, play stops and the disc reloads. All options are reset.

Program Play

You can programme a sequence of tracks to play in any order of your choosing. Program mode can be accessed from the handset only when the disc is stopped.

Example: to enter a programme of three tracks (The displays shown below are the cases when the info key is pressed on the handset).

- (1) Stop the CD playback.
- (2) Press the Prog button on the handset, Program On appears briefly on screen then the Program screen deploys. NO Track will be displayed.
- (3) Enter a track with the number keys. The track number flashes.
- (4) Press Store to program the track.
- (5) Enter another track (or the same track) with the number keys.
- (6) Press Store to program the track.
- (7) Repeat the procedure to enter all three tracks.
- (8) When all the tracks are entered:

To play the program: press ▶||

To cancel a program during programming: press the Stop key, program Off appears briefly on screen.

During Programme Play:

- (1) Pause, Stop, Previous track, Next track, Fast Forward, Fast Reverse are available.
- (2) Direct track selection with the number keys is disabled.
- (3) Repeat play (Repeat 1, Repeat All) is enabled but Random play is disabled.

Stopping Programme Play:

- (1) Press Stop once to stop play, Playback stops but the programme is retained in memory. To replay the programme, press ▶||.
- (2) When the programme is in stop mode, further tracks can be added following the procedure above.
- (3) Press Stop twice to stop programme play and erase the programme. Program Off appears briefly on screen.
- (4) Eject and load the disc will also erase the programme.

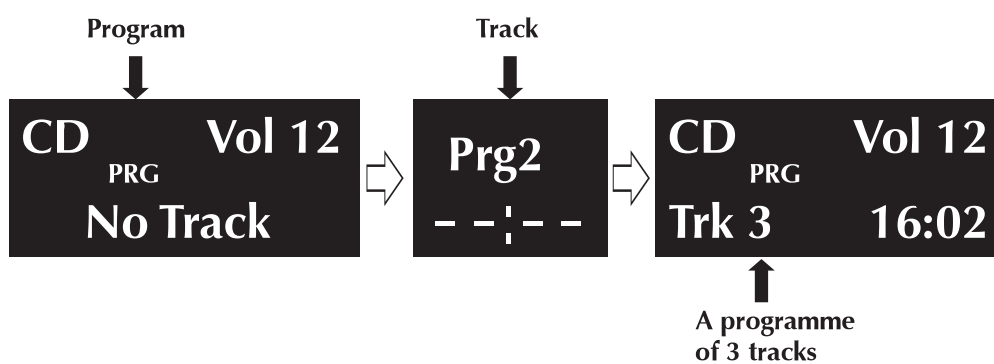
**Volume Adjustment**

To alter the volume level from the handset:

Press the Volume +/- keys to alter the level as required.

To alter the volume level from the front panel:

- (1) Touch and hold the SOURCE button to enter the volume adjustment mode.
- (2) Increase the volume level by touching the PLAY/PAUSE button.
- (3) Decrease the volume level by touching the SOURCE button.

If there is a delay of more than 2 seconds between pressing the SOURCE button and altering the volume, the procedure will self cancel.

The volume level is variable between 0 and 100.

Notes:

When first switched on: The system sets the default volume level to 50 - a safe low level.

When next switched on: If the unit was switched off with the volume level set above 50, the default level of 50 will be restored. If the unit was switched off with the volume level set below 50, the lower level will be displayed when the unit is next switched on.

Mute

Press the MUTE key on the handset to mute the sound output. The word "Mute" appears briefly on screen and then the play screen restores.

Pressing the info key on the handset will display "Mute", indicating that the player is in mute.



When the output is muted:

- Pressing the Mute key on the handset cancels mute.
- Changing the Volume level cancels mute.
- Bringing the unit into and out of Standby will cancel mute.

Playing a USB input

To use the USB input for the first time, a Windows PC will require the installation of the USB driver. Download the driver via www.quad-hifi.co.uk. please refer to the software file instructions. Connect your computer to the Artera Solus Play via USB cable (type A to Type B), change the Artera Solus Play mode to USB input using the handset or the button on the front panel.

"NoPC" will be displayed if there is no input signal via USB. The Artera Solus Play will lock digital inputs will lock onto the input data when there is an input signal for USB. The display screen will then indicate the presence of a digital signal and show the output sampling frequency of the music file in your computer.

If input sampling frequency is 384kHz, display shows PCM384 kHz.

If the format of music file is DSD64, display shows DSD2.8MHz.

If the format of music file is DSD128, display shows DSD5.6MHz.

If the format of music file is DSD256, display shows DSD11.2MHz.

Press the info key on the handset, display shows as follows: (e.g. On your computer, file sampling frequency is 384kHz or the format of music file is DSD 256)



HID function is available when playing PC USB. Play, Pause, Previous track, Next track can be controlled by the handset.

Playing an External SPDIF input

There are two optical and two coaxial SPDIF inputs for QUAD Artera Solus Play: OPT1-OPT2-DIG1-DIG2, press the required button on the handset or short touch the SOURCE button on the front panel to select the desired input.

“Unlocked” will be displayed if there is no input signal for SPDIF input. The display screen will then display the sampling frequency when there is an input signal for SPDIF input. The displays shown below are the cases when the info key is pressed on the handset. (e.g. input sampling frequency is 192KHZ for DIG1)

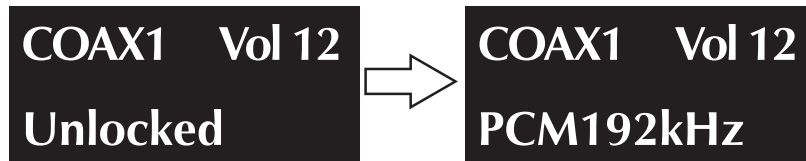

When playing an external SPDIF input, volume, mute, info and display functions only are available. All other control functions are carried out from the source unit.

DPLL Setting

DPLL setting is used for changing the bandwidth of the digital phase lock loop of the D/A converter to accommodate different levels of jitter on the incoming SPDIF signal.

Long press the corresponding digital source buttons on the remote control to enter the DPLL bandwidth setting. Select Low or High with Next/Pre button and Play/Pause to confirm the selection.

Low mode should be selected for signals with low jitter, while high mode should be selected for signals with abnormal jitter. For best audio quality leave this setting at the default value Low, only use High for a given input if the system is having problems locking onto the source.



BLUETOOTH

Please follow the instructions below instructions to connect your mobile device

- Select BT on your remote control or by short touching the SOURCE button on the front panel. Select “Artera Solus Play BT” on your mobile device.
- Once paired, the Artera Solus Play will show BT Connected on the display.
- Volume will be controlled by your mobile device, so you may need to increase the volume on the Artera Solus Play unit, depending on the maximum volume required.
- If you switch to another input on the Artera Solus Play, your mobile device will be disconnected from the Bluetooth connection.
- To reconnect, select BT on the Artera Solus Play and it will connect to the last paired device, or select Artera Solus Play.

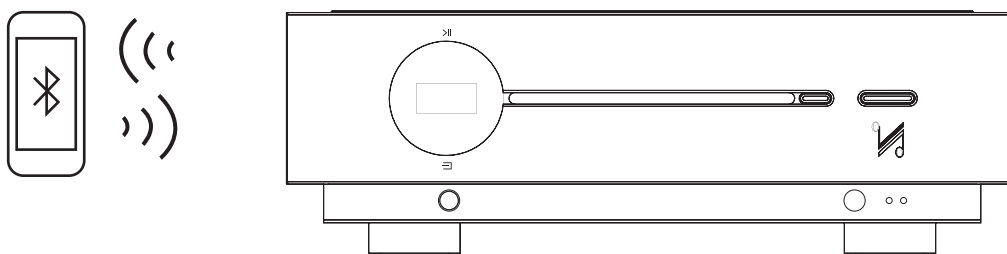

Select BT on your remote control or by short touching the SOURCE button on the front panel. Select Artera Solus Play BT on your mobile device.

DTS PLAY-FI® WIRELESS STREAMING TECHNOLOGY

Key Features

DTS Play-Fi puts you in complete control of your music. It gives you the freedom to effortlessly stream via Wi-Fi® from any device to any speaker in any room in your house. It's never been easier to listen to music with the people you love, in the place you love most. A place that memories are made and music plays the starring role.



WI-FI® TECHNOLOGY

DTS Play-Fi streams music over standard Wi-Fi networks, delivering perfectly synchronized audio, with no lag and zero loss in sound quality.

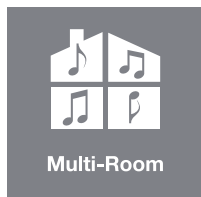

MULTI-ROOM

Enjoy music in every room of your house — all at once, perfectly synchronized, with no lag. You're in control.

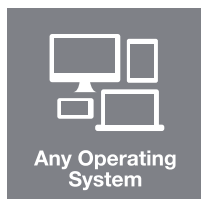

ANY OPERATING SYSTEM

Fully compatible with all operating systems: Apple iOS, Android™, Windows® PC, and Fire OS.

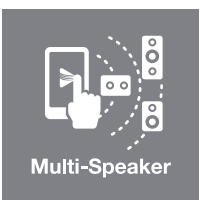

MULTI-SPEAKER

DTS Play-Fi is open to all speakers, no matter the size, shape, or brand. It's a truly all-inclusive system.

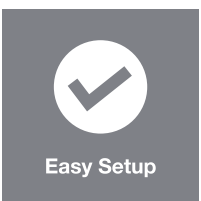

EASY SETUP

No logins, no complicated computer-based setups. Just download the APP and within minutes, you're ready to listen.



DTS PLAY-FI APP

Simply download the free APP and immediately send songs via Wi-Fi to any speaker in any room of the house.

For DTS patents, see <http://patents.dts.com>. Manufactured under license from DTS Licensing Limited. DTS, Play-Fi, the Symbol, and Play-Fi together in combination with the Symbol are trademarks of DTS, Inc. DTS and Play-Fi are registered trademarks of DTS, Inc. © DTS, Inc. All Rights Reserved.

DOWNLOAD THE APP

The DTS Play-Fi APP can be downloaded from the Google Play Store, Amazon APP Market or Apple App Store. For Windows PC you can download the Play-Fi Windows APP from the official website: <https://play-fi.com>



Network Settings

Wired network setting

Connect the Ethernet Port to the LAN port of a wireless router using a suitable cable. After switching on the Artera Solus Play, the white Wi-Fi LED on the front panel and red Wi-Fi LED on the rear panel will flash during the initialise phase of Wi-Fi mode. The Wi-Fi LED will slow-flash when the device goes into the wired network connection. If the connection is successful, the red Wi-Fi LED on the rear panel will go off, but the white Wi-Fi LED on the front panel remains illuminated.

Wireless Network Setting

You can connect to a wireless network using one of two modes: WPS Mode or Standard Mode.

WPS Mode:

In order to make the Artera Solus Play enter WPS Mode, switch the unit on and press and hold the Wi-Fi SET-UP button on the rear panel for 4 seconds. The Wi-Fi LED will double-flash and beep with a warning tone, the display shows "WPS" indicating that WPS Mode is active. Then briefly press the WPS key on your wireless router and the unit should connect to your wireless network automatically. This connection phase may take up to 60 seconds. If the connection fails, please try again.

Standard Mode:

After switching the Artera Solus Play on, press and hold the Wi-Fi SET-UP button on the rear panel for 8 seconds. For the first 4 seconds the Wi-Fi LED will double-flash and beep with a warning tone, the display shows "WPS". Keep holding the button down and after 8 seconds the Wi-Fi LED will flash quickly and also beep with a warning tone, the display shows "WIFI setup". The Standard connection mode is now active. The Wi-Fi hotspot will be found after several seconds and the display shows "Artera WIFI". Then the Wi-Fi LED will flash-breathe with a slow fluctuation between off and on (reflected by the white LED on the front panel). You can now use your Android or IOS device to enter the Wi-Fi password using the Play-Fi APP as follows (see next page):

WI-FI CONNECTION USING THE APP

For Android users:

- (1) Open the DTS Play-Fi APP, then click the 'Set-up your Play-Fi device' button.
- (2) When it has found the Artera Solus Play click the 'Set-Up'. Next input the Wi-Fi password for your wireless network. Then click the 'Next' button.
- (3) During installation the APP will find and update the Artera Solus Play Play-Fi settings to the latest version, this may take a few minutes.
- (4) After completing the network set-up and update, you can set a name for your Artera Solus Play device and begin enjoying the wireless streaming functionality.

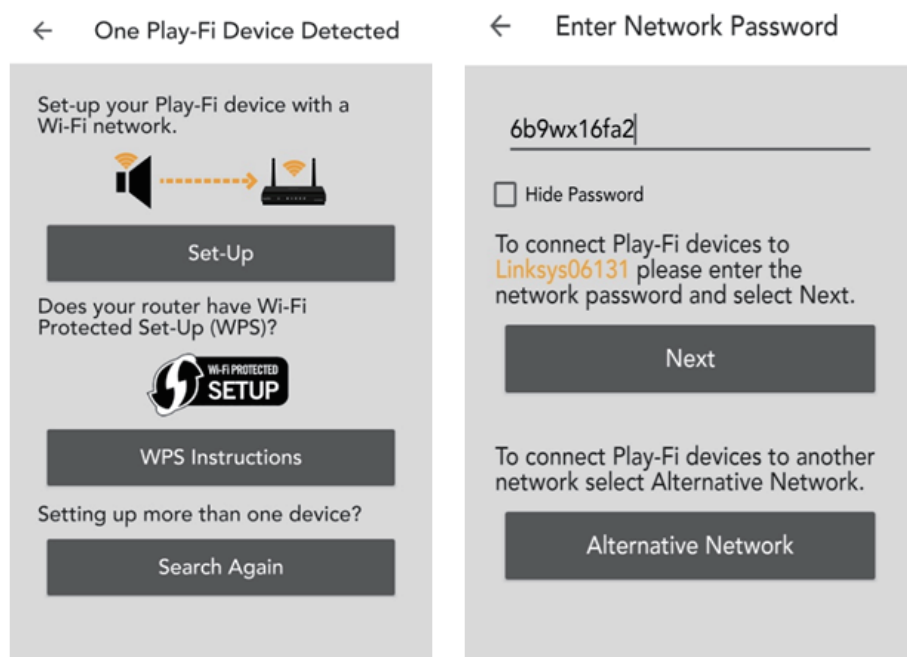

For Apple iOS users:

(1) Download the Play-Fi APP. Before opening the APP please switch to the Settings - Wi-Fi menu on your smartphone or tablet and select 'PlayFi2DeviceXXXXXX' from the options.

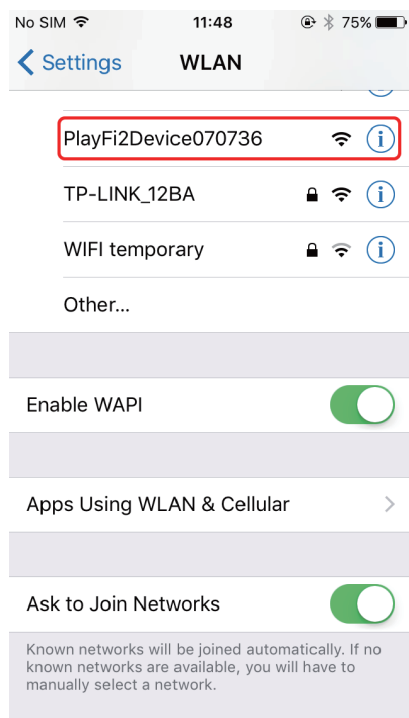

(2) Open the Play-Fi APP and find the Artera Solus Play Play-Fi Device name. Select it and enter your wireless network password.

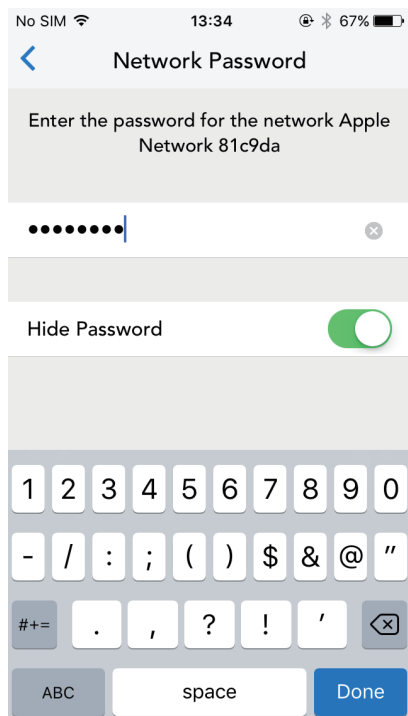

(3) During installation the APP will find and upgrade the Artera Solus Play Play-Fi settings which may take a few minutes.

(4) After completing the network set-up and upgrading you can set a name for your Artera Solus Play Device and use it.

WI-FI CONNECTION SETUP USING A WINDOWS PC OR MAC

For PC or Mac users:

If you cannot connect by using the Play-Fi APP, or you need to do some high-level options such as setting the static IP configuration, you can setup the Artera Solus Play using a web browser from your Windows PC or a Mac.

Set the Artera Solus Play to Standard Set-up mode, then follow these steps:

- (1) Connect your computer to the wireless Wi-Fi of the Artera Solus Play - it will show like 'PlayFi2Device000XXXXXX' or similar name. After connecting your computer may show 'No Internet Connection' - this is normal.
- (2) Open your Internet Browser and type: 192.168.0.1/index.html in the address bar.
- (3) Click the Enter key or click 'Continue' option in your Internet Browser.
- (4) This will open the Play-Fi configuration.
- (5) Select the 'Set Up' button.

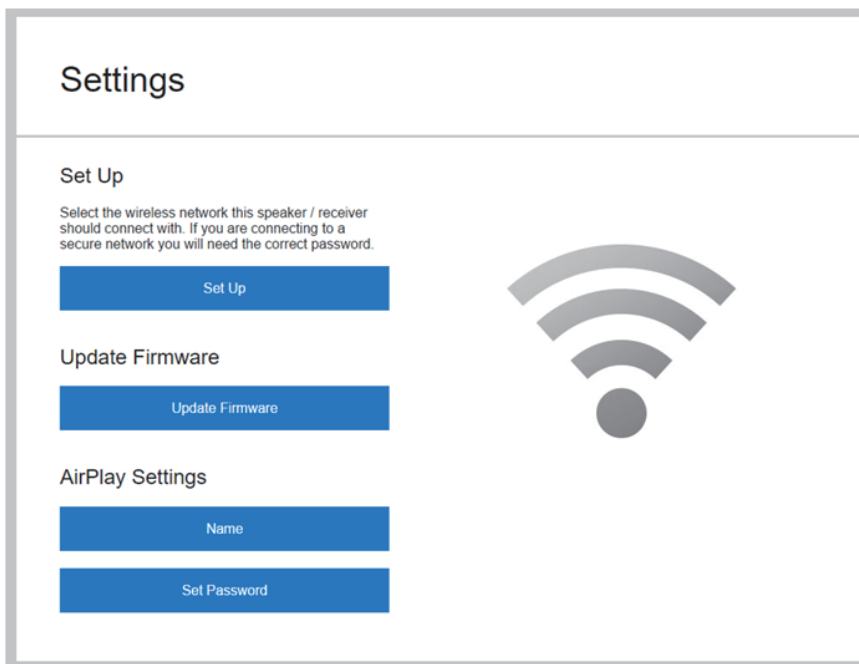

- (6) Select your wireless router Wi-Fi network.

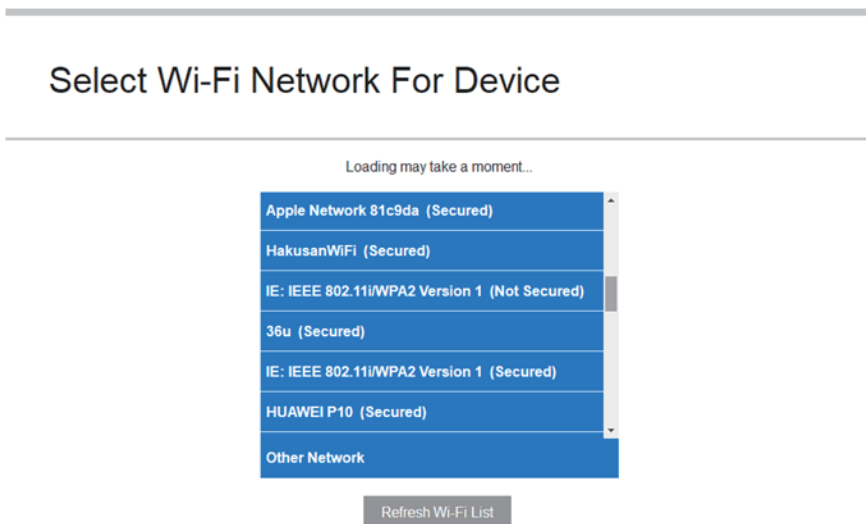

(7) Enter the password for your wireless network. Then click the 'NEXT' button.

Enter the Network Password

Enter Password:

NEXT >

(8) You can then name your Artera Solus Play Device and click 'NEXT'. The Wi-Fi connection will be made and you can use the device.

APP OPERATIONS

Device Selection

The DTS Play-Fi APP allows you to control and direct streaming music to a variety of devices throughout your home that use the DTS Play-Fi system. The streaming music also can be played by Spotify Connect and DLNA. You can set each device to have a unique name. You can also group devices into an Area, where each device will play the same music.

After connecting the network, open the DTS Play-Fi APP, click the '+' icon on the upper right corner of the APP display. Select an Area to add, then select a device on which to play the music. If you wish to play high-resolution audio files, the icon 'Hi-Res AUDIO' should be selected.

Music Services

DTS Play-Fi supports the world's most popular and exciting streaming music services, so you can enjoy your favorites at home just as easily as you do in the gym. See below for more information of streaming music service platforms. Please feel free to choose one you like.

(Note: some streaming music service platforms probably need to be registered.)

Amazon Music

Amazon Prime members can use Amazon's popular music service for free. A growing selection of over 2 million songs is always ad-free and on-demand, with curated playlists, personalized stations and unlimited skips. Upgrade to Prime Music Unlimited, and enjoy 10 million songs, weekly new releases, and more.



Deezer

With 43 million tracks, 100 million playlists, and a presence in 182 countries, Deezer literally covers the globe for its subscribers. Subscriptions start at \$9.99/month, and include ad-free playback, premium audio quality, and more.



iHeartRadio

iHeartRadio combines access to over 1,500 of the most popular live terrestrial and internet radio stations with unique live events and compelling custom features, like artist radio, personalized radio, and on-demand podcasts for FREE. Their new Plus and All-Access subscriptions allow you to pause, rewind, skip and save live radio content, stream on-demand music, and more.



Internet Radio

DTS Play-Fi has a built-in Internet Radio service that gives you access to thousands of radio stations and podcasts from around the globe. Instantly see your local favourites, or tune into the BBC, ESPN, Radio Disney, the Wall Street Journal, and more. Browsing is a snap, and if you find a station you love, just give it a star and it'll be ready to stream whenever you are. Free, no subscription required.



Juke

With more than 20 million tracks and a dedicated base of music fans, Juke's streaming service includes popular features like on-the-go playlists, new music discovery, and ad-free listening. DTS Play-Fi is the only multi-room audio platform to offer the Juke service.



KKBox

KKBox is Asia's leading streaming music service, with over 30 million tracks from 500 local and major labels, and the most comprehensive collection of Asia-Pop in the world. Featuring both free and premium options, the service also includes mood-based programming and supplemental content including music news, videos, concert updates and more.



On Device Music

DTS Play-Fi puts your mobile music collection at your fingertips, automatically finding and indexing the songs stored on your device. You can browse and stream by album, artist or genre, and even use your existing playlists. DTS Play-Fi supports local files in multiple formats, from MP3 all the way up to premium CD and lossless quality encoding. Free, with no subscription required.



Media Server

Got a hard drive full of music? Avid digital collectors can access and stream from media servers using DTS Play-Fi. The system automatically discovers and indexes music from DLNA and UPnP servers on your network. You can select and stream files in multiple formats via DTS Play-Fi, including premium tracks encoded at CD quality or even 24-bit/192kHz lossless content. No subscription required.



Napster

Napster integrates the heritage of streaming market pioneer Rhapsody into its premium, ad-free on-demand service. With 30 million tracks, instant playlist creation, and anytime, anywhere access, Napster is justifiably popular on multiple continents with millions of subscribers.



Pandora

Listen free to music you'll love, as Pandora's streaming service evolves with your tastes. Give songs a thumbs up or down, and your stations become more personal the more you listen. Enjoy the service at no charge with ads, upgrade to Pandora Plus for commercial-free streaming, or try Pandora Premium to add on-demand features and premium sound quality to your experience.



Qobuz

Based in France, Qobuz was founded and built around a premium audio quality experience. It boasts 70,000 albums available for streaming at 24/192, with many more streaming at 16/44 CD quality. The service also features in-depth artist profiles and editorial content.



QQMusic

China's largest music streaming service offers tens of millions of tracks and thousands of radio stations to its 400 million monthly active users. With free and premium tiers, and both local and international content, QQ Music is a dominant force in music listening in China.



SiriusXM

With over 150 channels of commercial-free music plus sports, talk, comedy, entertainment, news and more, it's no wonder that Sirius XM is one of the most widely used premium streaming services in North America. It's a snap to go from listening in your car to listening at home with DTS Play-Fi.



SoundMachine

Business never sounded so good! Whether it's in an office or a restaurant, a retailer or a hotel, background music enhances both the customer and the employee experience. Hundreds of stations and millions of songs, including the ability to create artist stations, so you can design the perfect sound for your brand. Fully licensed for business environments.



Spotify

Spotify transformed music listening forever when it launched in Sweden in 2008. Discover, manage and share over 50m songs for free, or upgrade to Spotify Premium to access exclusive features including offline mode, improved sound quality, Spotify Connect and ad-free listening. Today, Spotify is the most popular global audio streaming subscription service with 217m users, including 100m subscribers, across 79 markets. We are the largest driver of revenue to the music business today.



The Spotify Software is subject to third party licenses found here:

www.spotify.com/connect/third-party-licenses.

Use your phone, tablet or computer as a remote control for Spotify. Go to spotify.com/connect to learn how.



Tidal

High Fidelity Music Streaming is Tidal's hallmark. Every track on the service streams in premium audio format, with most in lossless CD quality or above. The service also boasts many exclusive new releases, artist-curated stations and in-depth features designed to complement the music offerings. Available to DTS Play-Fi users in the US and more than 50 other countries.

In addition to the support listed above, it also supports music services such as BBC, ESPN RADIO, HD tracks, NPR, tunein and so on, and there will be more music platforms involved in the development.

DISCLAIMER: Not all music services are available in all regions and countries.

Line In Mode

The Artera Solus Play supports wireless broadcasting of any of your music source inputs to other DTS Play-Fi audio solutions on your network. For instance, you can stream the turntable input from your Artera Solus Play to other DTS Play-Fi wireless speakers or streamers via the app. Perfect for a multi-room home audio solutions.

To activate this mode simply click the icon "+" on the top right corner of DTS Play-Fi App, select "Line In", then select the source unit, source channel and music genre. Finally select the secondary audio output device to which you wish to broadcast and click "Start Line In Broadcast" to play.

Note: there should be at least 2 or more than 2 units supporting the DTS Play-Fi system to supporting to use this function. The Broadcast mode can support all the input channels except Bluetooth functionality.

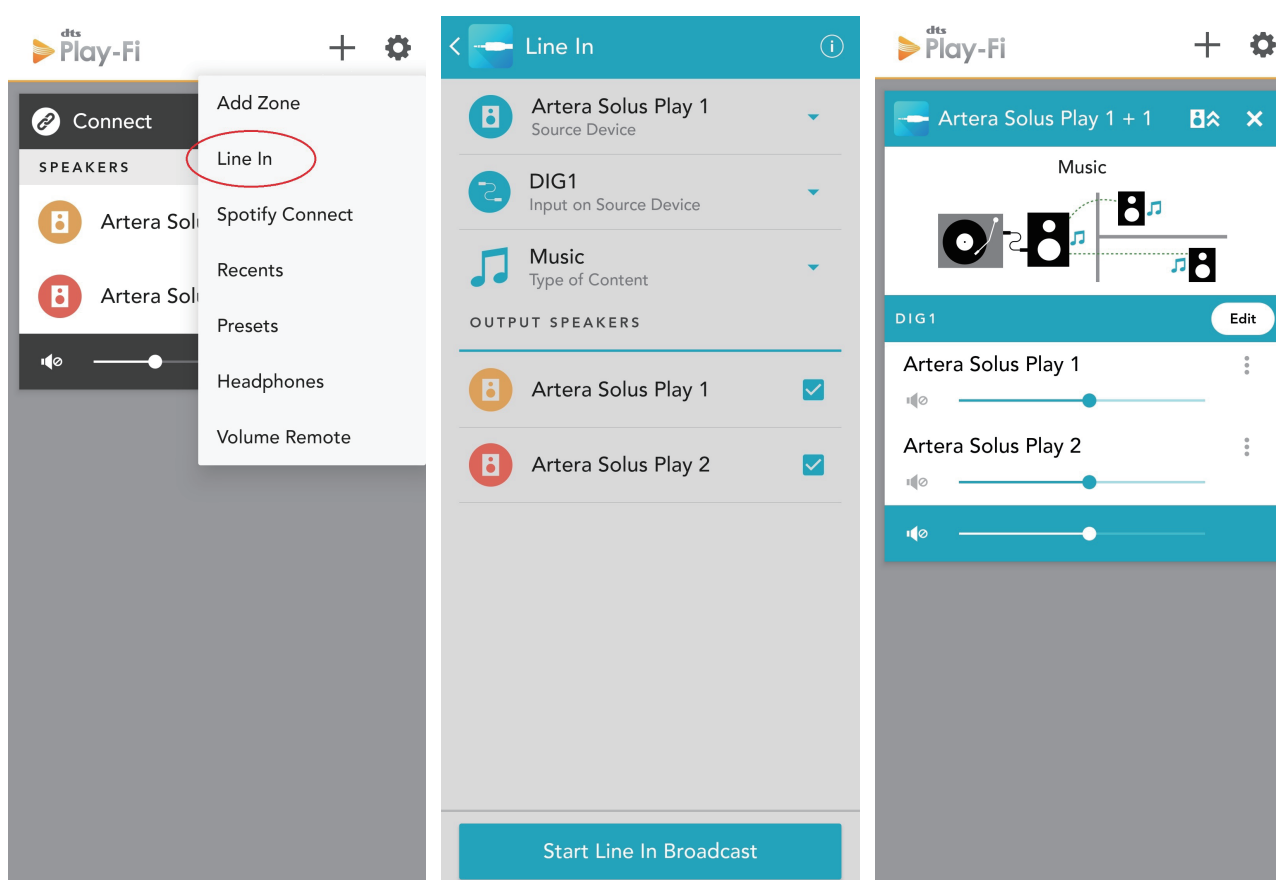

Speaker Groups

To stream music from Artera Solus Play to multi-room Devices such as DTS Play-Fi Speakers, open the DTS Play-Fi APP, find the Device or Speaker, give it a name and then add it.

To delete the Device or Speaker, just click on the right side of the Device name and then delete.

Currently it is not recommended to wirelessly stream Hi-Res audio to speakers if you want stable, uninterrupted playback.

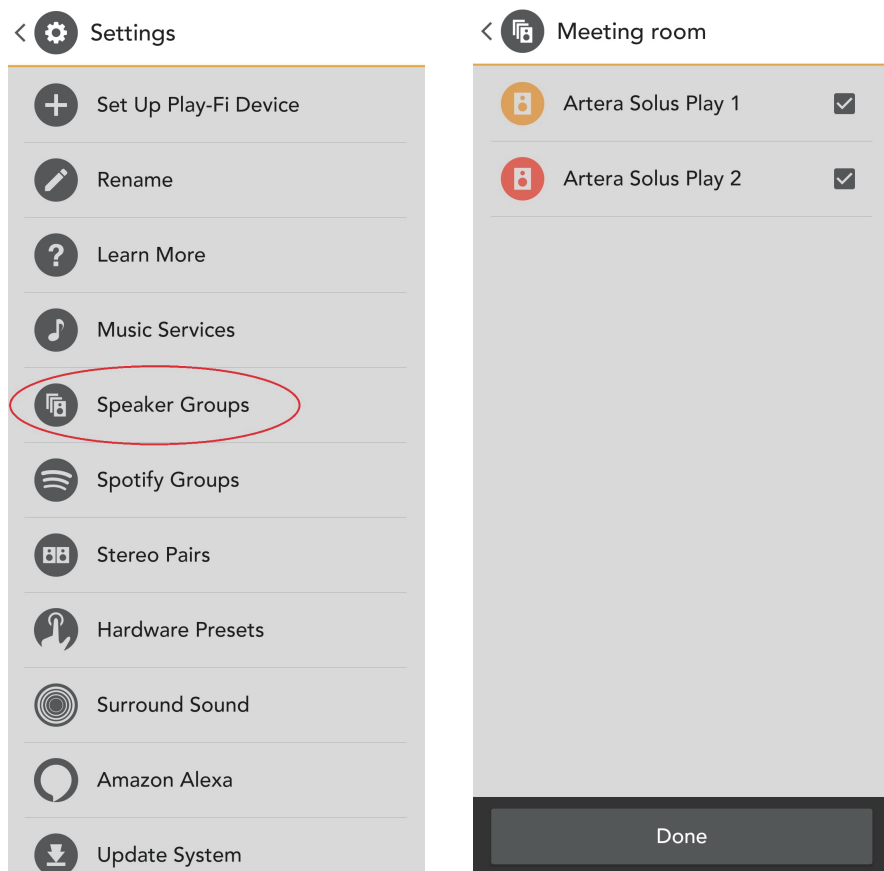

Spotify Group Setup

Open the Set Up of the DTS Play-Fi app and click the Spotify Group. Create a new group and name for it, then select any Play-Fi products you want to add into this group (on the right side). Any speakers that can't be added to the Spotify Group will show in grey. Any speakers that can't be joined to a Spotify Group will be greyed out. Once you're satisfied, head to the Spotify app to start streaming.

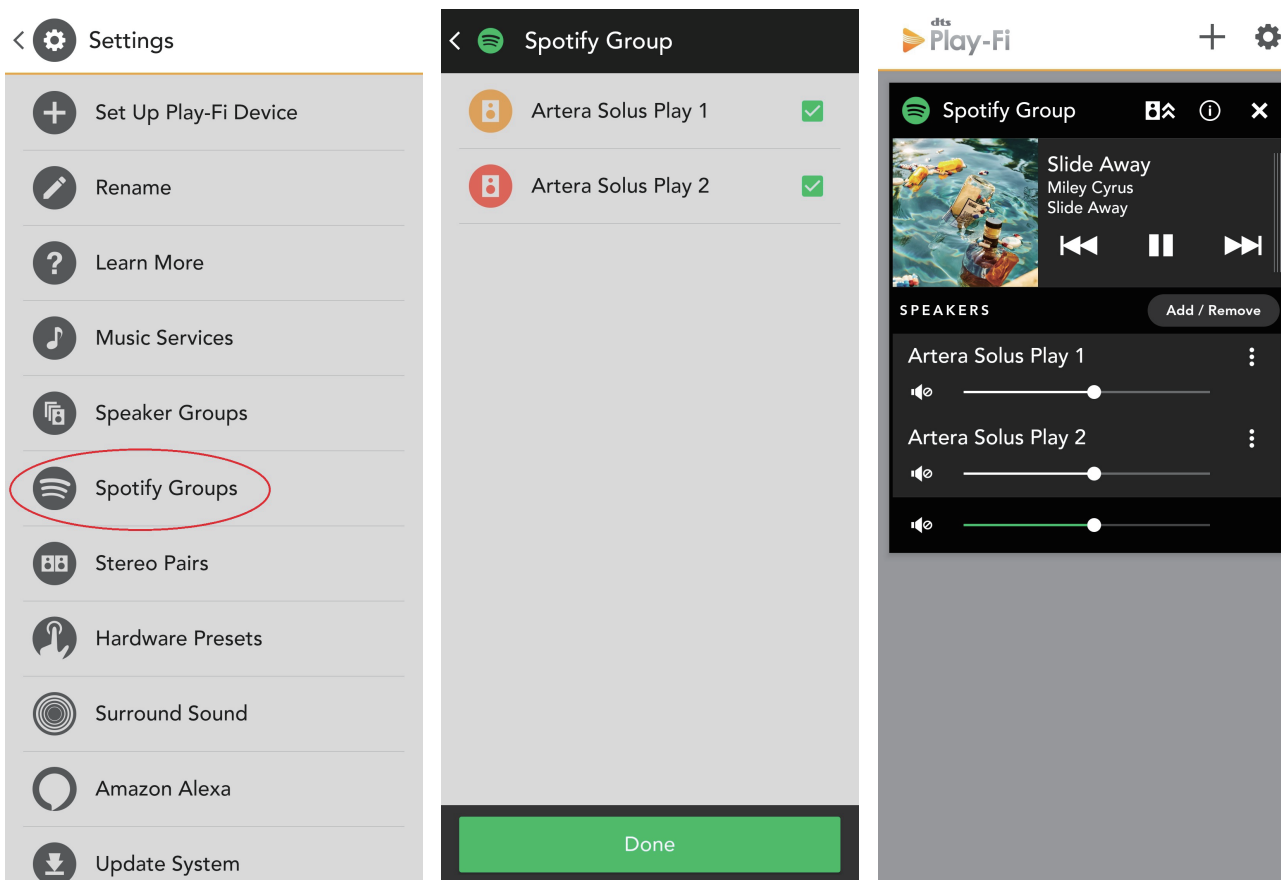

Surround Sound

So far, Artera Solus Play cannot support the play of "Surround Sound". For the common problems in utilization and fault diagnosis, you can open the APP settings to find the "Fault diagnosis", then enter the DTS Play-Fi website knowledge base which has the detailed information.

Update System

If there is an update available, click "Update System" and the process will carry on automatically. Click "About", you can see the DTS Play-Fi's APP version and the status of network connection, IP address and versions of the module software and MCU. For 'Advanced Settings' you can choose from various options - the default mode is recommended.

DTS Play-Fi Windows Application

With your PC running Windows 7, 8, 8.1 or 10, the DTS Play-Fi Windows app allows you to stream from any source on your PC (apps, services or Web based) including Spotify, Google Play, iTunes, Xbox Live and more.

Music mode: the free version of the Windows app defaults to Music mode, then select the Artera Solus Play to play.

Video mode: allows you to sync the audio from any video, whether from a movie file or YouTube, to any one Play-Fi device on your network.

To use Video mode upgrade your app to the Play-Fi HD version. Click the option 'Video mode' then select the device to play.

Play-Fi HD is the only Wi-Fi streaming solution to include advanced codecs and proprietary QoS (Quality of Service) technology. That means audio is delivered with astonishing accuracy, even in the busiest network conditions.

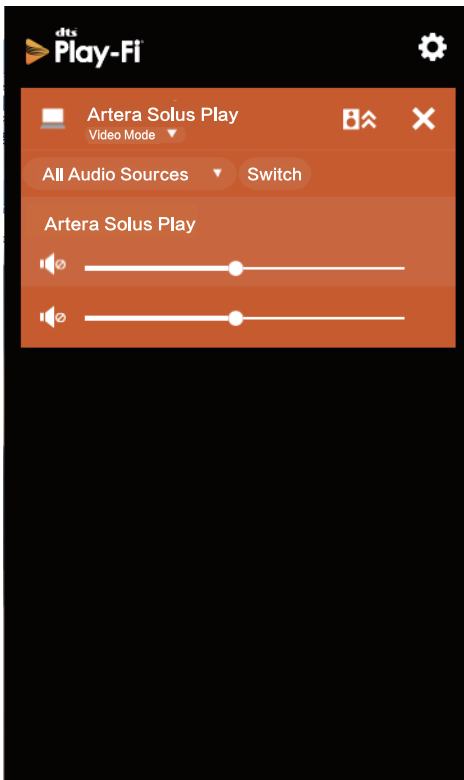
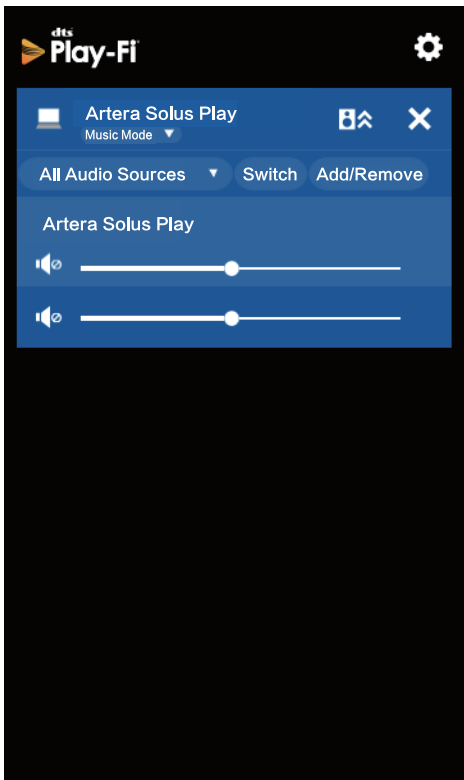

Altering the Display Brightness

Short press the Display key on the handset, the word “Display Off” appears briefly on screen and the display will revert to off.

Short press the Display key on the handset again, the word “Display On” appears briefly on screen and the display will revert to on.

There are 8 levels of brightness available. Press and hold the Display key on the handset, the word “Brightness Level 8” appears briefly on screen, short press the Display key on the handset to repeatedly alter the level from 1-8.

The Brightness level will be retained on Artera Solus even when it enters Standby but not Power Off.

Brightness
Level 8

MENU SETTING

Digital Filter (digital inputs only)

The Artera Solus Play offers a choice of filters to optimise playback on different devices, resolutions and to tailor the sound to fit your personal taste.

There are 4 filter choices: Fast, Smooth, Wide and Narrow. The default digital filter for the Artera Solus Play is “Smooth”. Press and hold the Prog key on the handset to enter the Menu options then toggle through using the **◀◀/▶▶** the menu to select ‘Digital Filter’.

Toggle through the different settings and use the **▶||** button to select your filter of choice.

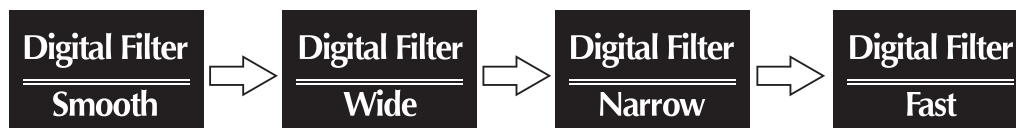

The Digital Filter state will be retained on Artera Solus Play even when it enters Standby or Power Off.

Filter Characteristics:

Smooth: The ‘Smooth’ filter is a digital filter which optimum sampling theory and is designed for near perfect technical response in the frequency domain. It’s quite useful for simpler acoustic recordings as it sounds more natural. The filter has a slightly lower bandwidth but superior rejection of out of spectrum noise and thus has a very clear, smooth open sound.

Wide: The ‘Wide’ filter has a gentle rate of attenuation, minimum ‘time-domain ringing’, minimal out of spectrum noise and thus is quite useful for high sample rate (96kHz and above) files. It has a very ‘clean’ sound, even if it doesn’t have the transient impact of ‘Fast’.

Narrow: The ‘Narrow’ filter typifies industrial standard characteristics (-6dB at $1/2 F_s$ with significant time-domain ringing) and is included here for comparison purposes). This filter has a high jitter tolerance.

Fast: The ‘Fast’ filter exhibits no ringing – the transient nature of the music is preserved. This type of filter has a purity and ‘naturalness’ to the sound quality.

DSD Bandwidth

The DSD Bandwidth can be widened to suit high performance hi-fi equipment and particular DSD audio files.



Volume Limit

For protection of equipment and other uses, a volume limit can be applied between 0 - 100.

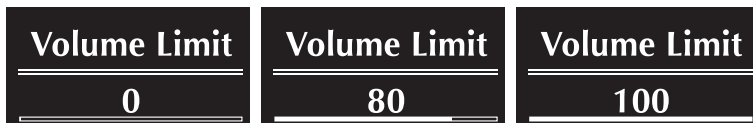

Gain

The Output Gain feature applies an offset value (adjustable between -8dB to +8dB) to the volume control.

The offset allows the volume control to be used in its optimal range (in terms of step resolution), accommodating the use of various types of loudspeakers with different sensitivity levels.



Balance

Balance of left and right channels can be adjusted.



AvDir(AUX2)

AV Bypass mode for AUX2, the gain of the AUX2 audio path is set to fixed level output (0dB).

This is for use with sources with built-in volume control such as AV processors.



Auto Standby

Artera Solus Play has three standby modes, editable via the Menu

Auto Standby Never: Artera Solus Play will only enter standby through user control

Auto Standby 20 Minutes: If the CD is stopped for 20 minutes, or if there is no input signal for 20 minutes, the Artera Solus Play will enter standby.

Auto Standby 1 Hour: If the CD is stopped for 1 hour, or if there is no input signal for 1 hour, the Artera Solus Play will enter standby.



Brightness

The Artera Series brightness can be adjusted from a low level to a bright level, adjustable in 8 increments.



Default Channel

Any channel on the Artera Solus Play can be set as the default channel. Additionally, this can be set, using the 'Recall Last Input' feature.



CD Time

Users can select the track time display in four formats. 'Track Time Forward' shows the individual track playback time. 'Track Time Remain' displays individual track time remaining. 'Disc Time Forward' displays the playback time of the whole CD. 'Disc Time Remain' displays the remaining time left on the whole CD.



Factory Reset

The Artera Solus Play can be restored to factory default settings. To do so, toggle through the menu options using the ◀◀/▶▶ keys. Confirm the Factory Reset ▶▶.



Firmware

The final menu option displays the current firmware installed on the Artera Solus Play.



SPECIFICATIONS

(All measurement made with 230V supply)

| Model | Artera Solus Play |
|-------------------------------------|---|
| General Description | CD Player, DAC, Pre-Amp with Integrated amplifier |
| Key Technology & Features | DSD (up to DSD256 Compatible) / Bluetooth (aptX) DTS Play-Fi Technology |
| Audio File Formats | ALAC, WAV, FLAC, AIFF, WMA, MP3, AAC, AAC- HE, AAC+, DSD64, DSD128, DSD256 |
| D/A Converter | ESS ES9018 32bit DAC |
| USB Input | USB B (PC / MAC) |
| Digital Audio Inputs | 2 x Optical TOSlink, 2 x RCA (DIG1, DIG2) |
| Digital Audio Outputs | 1 x Optical TOSlink, 1 x RCA (DIG) |
| Analogue Inputs | 2 x RCA (AUX1, AUX2) |
| Analogue Outputs | 2 x RCA, 2 x Balanced XLR, 6.3mm Headphone Jack |
| Speaker Outputs | 1 Pair Speaker Terminals |
| Sample Rate (USB B) | 44.1kHz, 48kHz, 88.2kHz, 96kHz, 176.4kHz, 192kHz, 384kHz |
| Sample Rate | 44.1 - 192kHz (Digital Inputs / Outputs) |
| Standby Power Consumption | <0.5W |
| Pre-Amplifier Section | |
| Output Level (1kHz) Variable Output | 0 - 4 Vrms (Pre Outputs) 0 - 8 Vrms (Balanced Outputs) |
| Frequency Response | 20Hz-20kHz, 1kHz (± 0.2 dB) |
| Total Harmonic Distortion | <0.002% (20Hz-20kHz) |
| Signal to Noise Ration(S/N) | >103dB (1kHz) >110dB (A Weighted, 1kHz) |
| Channel Separation | >100dB (1kHz) |
| Power Amplifier Section | |
| Rated Power Output | 2 x 75W (8 Ω) |
| Frequency Response | ± 0.5 dB (20Hz-20kHz, 1kHz) |
| Total Harmonic Distortion | <0.009% (10W 20Hz-20kHz) |
| Signal to Noise Ration(S/N) | >100dB (A Weighted, ref.75W) |
| Channel Separation | >82dB (A Weighted, ref.1W) |
| Dynamic Range A-wtd | >98dB |
| Power Requirement | 220V-240V~50-60Hz (depending on region) 100V-120V~50-60Hz |
| Dimensions & Weight | |
| Dimensions (Unpacked) | 320 x 320 x 105mm |
| Dimensions (Packed) | 465 x 465 x 220mm |
| Net Weight | 11.5 kg |
| Gross Weight | 13.8 kg |

CARE AND CLEANING

While cleaning is in progress the AC power cord must be unplugged from the AC power supply socket.

The surface of the equipment should be cleaned with a damp soft cloth. Solvent based cleaning materials should not be used as they may damage the finish.

If you have any queries regarding the use of QUAD equipment, consult your dealer.

WARRANTY

QUAD equipment is guaranteed against any defect in material and workmanship for a period of one year from the date of purchase. Proof of purchase is required for warranty claims.

Please complete and return the enclosed Warranty Registration Form. Within the warranty period QUAD will undertake replacement of defective parts free of charge provided that the failure was not caused by misuse, accident or negligence. Your statutory rights within the territory in which you purchased the equipment is not affected by this warranty.

QUAD carries out regular reviews and reserves the right to adjust the specifications and performance from time to time.

SERVICING

Product service enquiries should, in the first instance, be referred to the supplying dealer. If you need to return your equipment for servicing we recommend that it is shipped in its original packing.

In cases of difficulty or for other product enquiries please contact that appointed QUAD distributor for your country. Principal Service Centre addresses and contact numbers can be found below.

For information of worldwide authorized service centres, please read worldwide distributor list on the QUAD website: www.quad-hifi.co.uk.

INTERNATIONAL SERVICE CENTRE ADDRESS

IAG House, 13/14 Glebe Road, Huntingdon, Cambridgeshire, PE 29 7DL, UK

Tel: +44 (0) 1480 452561 Email: service@quad-hifi.co.uk



Correct Disposal of this product. This marking indicates that this product should not be disposed with other household wastes throughout the EU. To prevent possible harm to the environment or human health from uncontrolled waste disposal, recycle it responsibly to promote the sustainable reuse of material resources. To return your used device, please use the return and collection systems or contact the retailer where the product was purchased. They can take this product for environmental safe recycling.







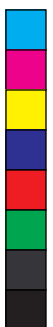

QUAD

IAG House, 13/14 Glebe Road, Huntingdon, Cambridgeshire, PE29 7DL, UK
Tel: +44(0)1480 452561 Email: service@quad-hifi.co.uk <http://www.quad-hifi.co.uk>
IAG reserves the right to alter the design and specifications without notice. All rights reserved © IAG Group Ltd.
QUAD is a member of the International Audio Group.

