







Let the show begin.

Beovision Harmony is designed for the ultimate cinematic and immersive audio-visual experience. With a new and exciting take on the TV cabinet concept, Beovision Harmony is capable of transforming itself from an elegant piece of furniture while not in use into an unrivalled centre of entertainment. Watch the magic unfold.



Important features

-  Exceptional Bang & Olufsen sound paired with the best OLED picture performance
-  Striking design combined with magically choreographed movement
-  Combining wood, fabric and aluminium with meticulous attention to details
-  Ease-of-use at its heart
-  Built for multiroom music experiences

01.2021V08

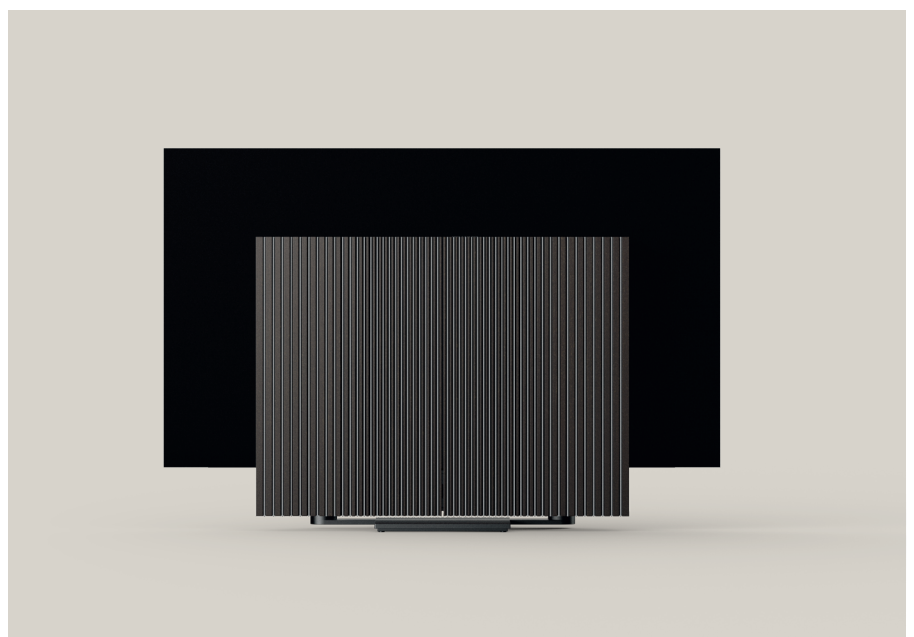



Basic

**BEOVISION HARMONY
WITH A 65" SCREEN**

PLACEMENT OPTIONS

- Floor stand
- Motorised floor stand
- Wall bracket

WEIGHT

Bang & Olufsen Sound center
incl. speaker cover: 71.8 kg
LG 65" G model OLED TV: 22.8 kg
Motorised floor stand: 20.7 kg
Floor stand: 10 kg
Wall bracket: 2 kg

MOTORISED FLOOR STAND

The maximum turning angle is
+/- 35 degrees. It requires 20 cm
distance from wall.

If the rear part of the floor stand is placed
10 cm from the wall, the screen can be
turned: +/-26 degrees.

Product Dimensions

FLOOR STAND

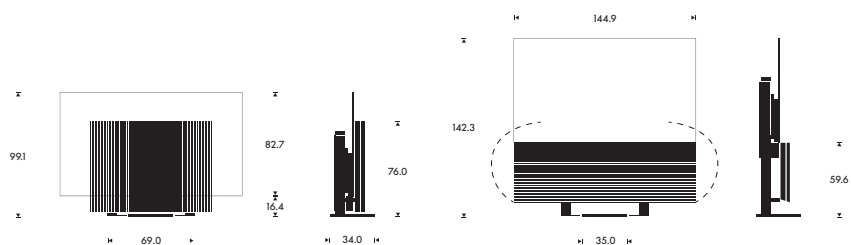

MOTORISED FLOOR STAND

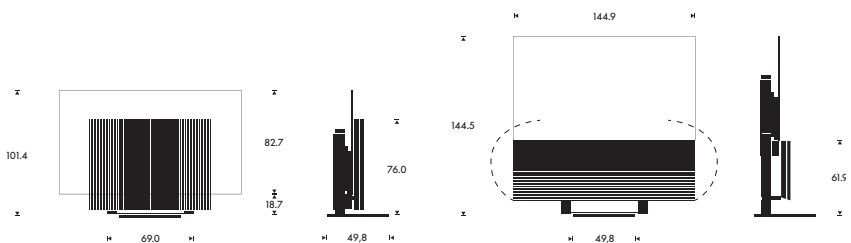

WALL BRACKET

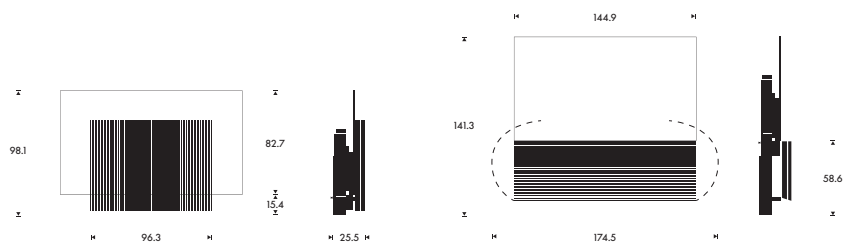



Basic

**BEOVISION HARMONY
WITH A 77" SCREEN**

PLACEMENT OPTIONS

- Floor stand
- Motorised floor stand
- Wall bracket

WEIGHT

Bang & Olufsen Sound center
incl. speaker cover: 75.3 kg
LG 77" G model OLED TV: 35.1 kg
Motorised floor stand: 20.7 kg
Floor stand: 10 kg
Wall bracket: 2 kg

MOTORISED FLOOR STAND

The maximum turning angle is
+/- 35 degrees. It requires 28 cm
distance from wall.

If the rear part of the floor stand is placed
10 cm from the wall, the screen can be
turned: +/-21 degrees.

Product Dimensions

FLOOR STAND

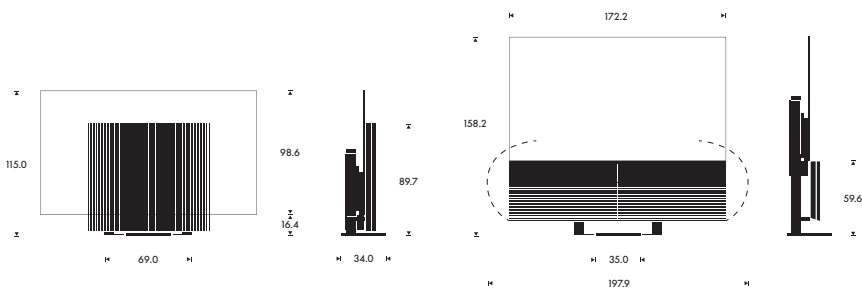

MOTORISED FLOOR STAND

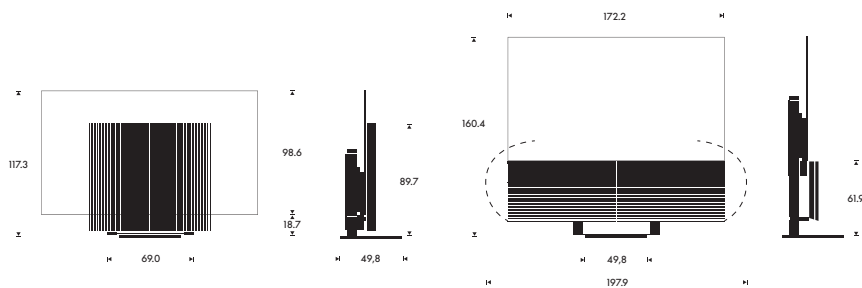

WALL BRACKET

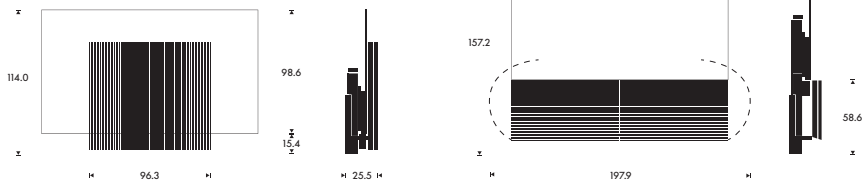



Basic

**BEOVISION HARMONY
WITH A 83" SCREEN**

PLACEMENT OPTIONS

- Floor stand
- Motorised floor stand
- Wall bracket

WEIGHT

Bang & Olufsen Sound center
incl. speaker cover: 76.4 kg
LG 83" G model OLED TV: 40.9 kg
Motorised floor stand: 20.7 kg
Floor stand: 10 kg
Wall bracket: 2 kg

MOTORISED FLOOR STAND

The maximum turning angle is
+/- 35 degrees. It requires 32 cm
distance from wall.

If the rear part of the floor stand is placed
10 cm from the wall, the screen can be
turned: +/-19 degrees.

Product Dimensions

FLOOR STAND

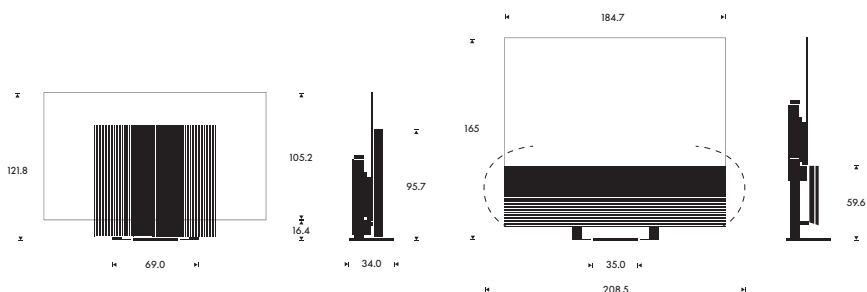

MOTORISED FLOOR STAND

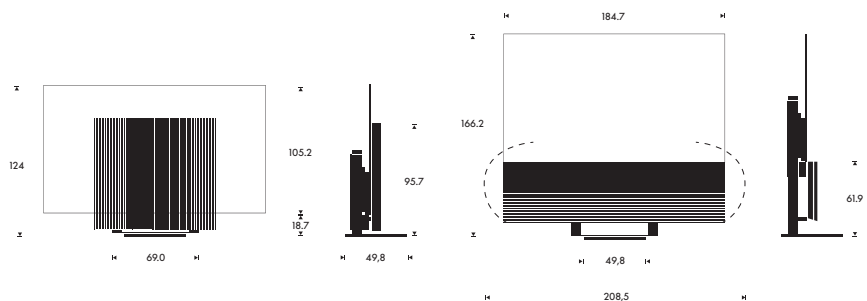

WALL BRACKET

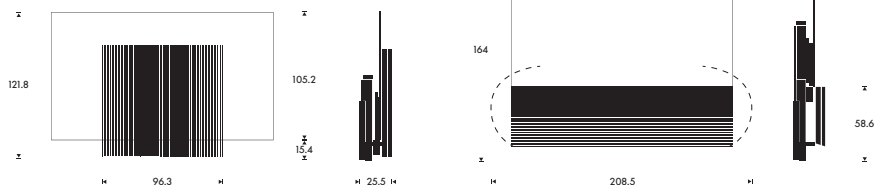



Basic

**BEOVISION HARMONY
WITH A 88" SCREEN**

PLACEMENT OPTIONS

- Floor stand
- Motorised floor stand

WEIGHT

Bang & Olufsen Sound center
incl. speaker cover: 90.7 kg
LG 88" Z model OLED TV: 54.9 kg
Motorised floor stand: 20.7 kg
Floor stand: 10 kg

MOTORISED FLOOR STAND

The maximum turning angle is
+/- 35 degrees. It requires 38 cm
distance from wall.

If the rear part of the floor stand is placed
10 cm from the wall, the screen can be
turned: +/-16 degrees.

Product Dimensions

FLOOR STAND

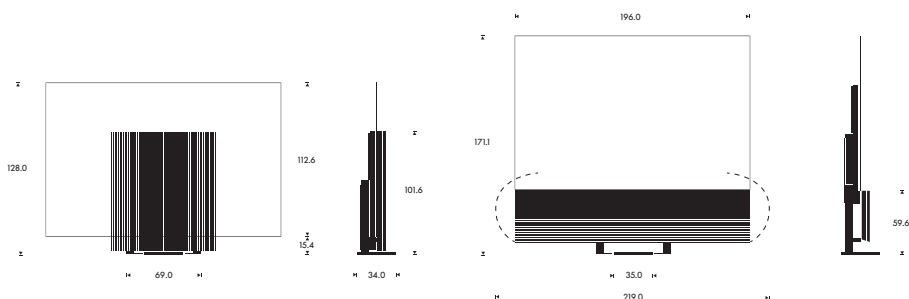

MOTORISED FLOOR STAND

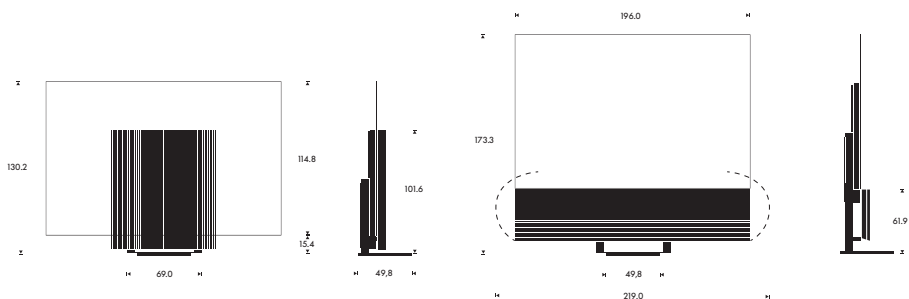



Basic

**BEOVISION HARMONY
WITH A 97" SCREEN**

PLACEMENT OPTIONS

- Floor stand
- Motorised floor stand

WEIGHT

Bang & Olufsen Sound center
incl. speaker cover: 83.1 kg
LG 97" G model OLED TV: 57.0 kg
Motorised floor stand: 20.7 kg
Floor stand: 10 kg

MOTORISED FLOOR STAND

The maximum turning angle is
+/- 35 degrees. It requires 42 cm
distance from wall.

If the rear part of the floor stand is placed
10 cm from the wall, the screen can be
turned: +/-15 degrees

Product Dimensions

FLOOR STAND

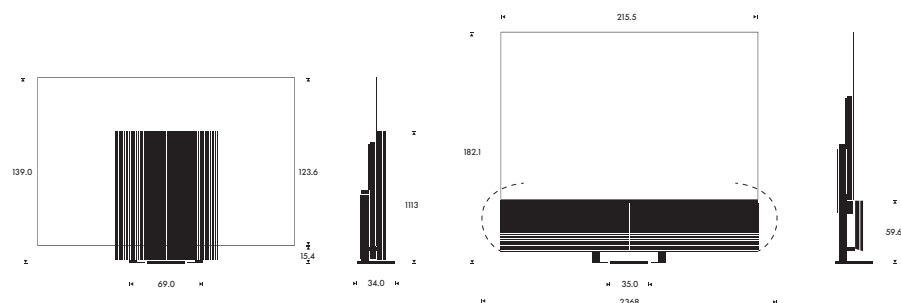

MOTORISED FLOOR STAND

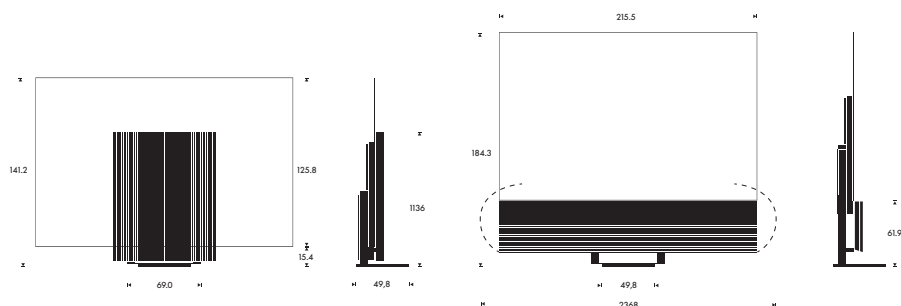



Technical

SOUND

Integrated fully active three channel stereo (centre and stereo)

- 1 x 1" tweeter
- 2 x 2.5" fullrange drivers
- 1 x 4" midrange/woofer
- 2 x 4" woofers

Amplifiers

- 1 x 50 watts for centre tweeter
- 2 x 50 watts for fullrange drivers
- 3 x 100 watts for midrange/woofers

Integrated 7.1 surround sound module

Adaptive Bass Linearisation

Sound modes and Speaker groups

TrueImage up and downmixing

Immaculate Wireless Sound integrated

for a full wireless surround solution with connection of up to 8 speakers

REMOTE CONTROL

2way Bluetooth control via Beoremove One BT

LG TV SCREEN

65" / 77" / 83" / 97" screen with 4K resolution

77" / 88" screen with 8K resolution

Self-lighting OLED: Perfect Black,

Intense Color, Infinite Contrast

Dolby Vision IQ

webOS & ThinQ AI

AUDIO STREAMING

- Apple AirPlay 2
- Bluetooth
- DLNA
- Chromecast built-in
- Deezer (incl Deezer HiFi)
- Spotify Connect
- Bang & Olufsen Radio
- QPlay 2.0 (China Specific)

MULTIROOM

Apple AirPlay 2, Chromecast and Beolink Multiroom technologies are integrated to create wireless multiroom setup

Other information

DESIGNER

Torsten Valeur, Valeur Designers

PATENT

Bang & Olufsen has a pending patent on the mechanism providing the movement of the speaker covers where the close gap between the covers stays the same during the whole movement, which gives a surprising effect



Soundcenter speaker
cover options:

**NATURAL ALUMINIUM
AND OAK WOOD**



**NATURAL ALUMINIUM
AND GREY MÉLANGE
FABRIC**

Not available for 97"



**GOLD TONE ALUMINIUM
AND LIGHT OAK WOOD**



**BLACK ANTHRACITE
ALUMINIUM AND
DARK OAK WOOD**

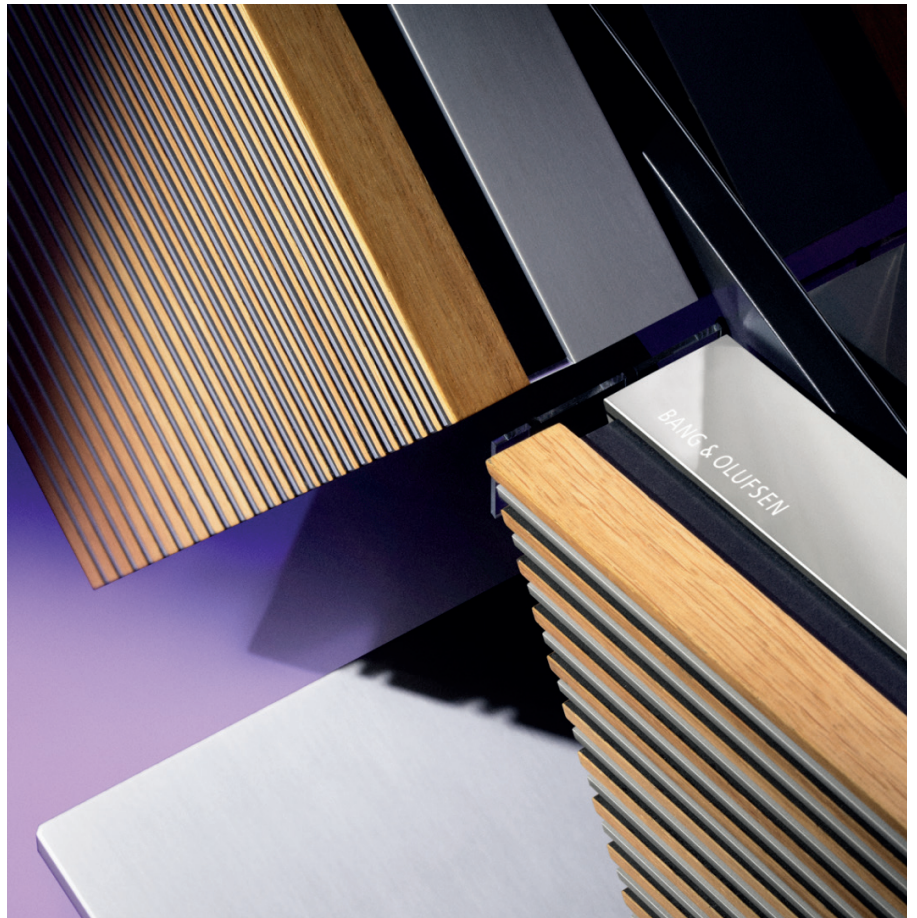

Available for customisation

With the B&O AR Experience app,
you can preview the customisation
options and view Beovision Harmony
in different rooms.

Ask in store or visit
www.bang-olufsen.com
for more information.

